

EX HKA ... / 100 AT

Radiator with temperature controller - regulator



Identification	 II2G Ex emd IIC T3 bzw. T4
EC-type examination certificate	ZELM 03 ATEX 0174X
Ambient temperature range	-40°C - +80°C
Heating capacity	max. 370 W
Rated current	6 A
Rated voltage	230 V
Limiter T3/ T4	112°C
Degree of protection	IP 65

Radiator

Electrical heater for the heating of instrument protection boxes. The HKA is available as pure heater or else with an integrated temperature limiter. There are different temperature monitors available for the control process. Through reset the limiter can be reset again.

The heater is available with or without limiter or as pure heater (HKA/ U).

Equipment and protective systems for the intended use in hazardous areas according to directive 2014/34/EU

Radiator	EX HKA .../ 100 AT
----------	--------------------

TABLE OF CONTENTS

1.0	General description	2
1.1	Area of application	2
1.2	Temperature limitation	2
1.3	Protective measures.....	2
2.0	General technical data	2
2.1	Table 1.....	3
3.0	Serial number	3
3.1	Order reference	3
4.0	Installation.....	3
5.0	Project (only für T3 model)	4
5.1	Table 2 (only for T3 model)	4
5.2	Diagramm 1 (only for T3 model)	4
6.0	Connectionplan.....	4
7.0	Cabinet construction and temperature points.....	5
8.0	Nameplate.....	6
9.0	Dimensions.....	6



Warning

The installation, configuration and commissioning may only be carried out by accordingly trained persons. On-site installation and safety requirements must be met.



Proviso

Technical changes are reserved. Changes, errors and omissions do not justify any claim for damage. For safety components and systems the relevant standards and regulations must be observed as well as the relevant operating and assembly instructions.



Installation notes

For installation and operation the EN 60079-14 ff and the applicable installation regulations as well as the generally recognized rules of technology and this manual prevail. The electrical data and the special conditions of the EC-type examination certificate must also be ensured after the assembly. The monitoring of the ambient temperature must be ensured by an external sensor (e.g. TRSC).

For the heater itself this is not necessary. However it is useful if the temperature in the protective cabinet shall not exceed this value. In case of doubt the manufacturer should be contacted. Frequently more heating elements are installed in one protective box. In this case their effect on the total installation should be considered. If arbitrary combinations are chosen, the Ex HKA does not necessarily represent the hottest surface within the protective cabinet heating. The primary rule is, that the limitation of the maximum surface temperature is only valid for the Ex HKA and that further considerations are not covered by the EC-type examination certificate. We are always available for advice on specific issues.

Servicing

The user has to test the security function (disconnecting of the relais contact when exceeding the set limit temperature) in cyclic intervals. The test cycle results from the determination of the EN 61508 and must be conducted every 5 years.

Maintenance

The for the repair / maintenance / inspection applicable provisions of the EN 60079-14 und EN 60079-17 and any other applicable requirements, which reflect the state of the art must be



observed.

Current error conditions are reliably detected by the integrated and to be taken safety measures as for example fuses and residual current device.

Special conditions

The heater may only be operated with a temperature control device, which in particular will ensure the maximum ambient temperature of 40 °C during normal operation. A phase loss in AC power must be considered if necessary.

The heater may only be installed so that a local overheating can not be assumed.

A suitable overcurrent protective device must be applied to the heater, which prevents excessively high ground currents safely.

Repair

The cable must not be damaged. Especially with the unprotected model, damages caused by metal parts or the radiator itself should be avoided.

Dismantling in reverse order to mounting.

- The device is irreparable. An intervention is not allowed.

- Failure to comply with the instructions for this manual and the state of the art for the installation will void the warranty.

Read this manual before you take the device into operation. Keep the manual at a place accessible for all users at any time.

Please help us to improve this manual. Your suggestions are welcomed.

Please contact us for technical questions!

TELEPHONE: +49 (0)611 761 393

TELEFAX: +49 (0)611 711 462

E-Mail: info@erich-ott.de

1.0 GENERAL DESCRIPTION

Characteristics

- high performance
- optimizes radiation through black paint and sealed heating ribs
- regulators and limiters are integrated into the terminal block
- mounting bracked included





The radiator consists of two flat-tube heat conductors, which are pressed into heating ribs. The standard version is galvanized and lacquered. The junction box contains the temperature limitation, temperature control and possibly the temperature signal and is filled with resin. The connecting line is about 1,20 m long and for the standard model made of silicone.

Special version:

1. V2A protective sleeve over connecting line
2. Thermostat for signaling
3. PTFE - coating

For the assembly of mounting iron four holes with a diameter of 6,5 mm are provided. The heating elements can be installed into the cabinets in two different positions, vertical and horizontal. Because of this and due to the small need of space they can be easily installed into present, with equipment provided, cabinets afterwards. The heating properties which result from the different installation situations will be explained later on.

2.0 GENERAL TECHNICAL DATA

Main circuit	
Series voltage	≤ 252 V ~
Rated output power	max. 370 W
Dimensions (mm)	210 x 273 x 54
Weight	3,5 kg
Type of protection	IP 65 / DIN 60529:1991
Temperature setpoint	100 °C
Hysteresis	≤ ± 7 K
Limiter	112 °C
Power temperature	see chapter 3.0
Ambient temperature range	-40°C bis +80°C
Fuse	≤ 16 A
Control circuit / Guard	
Rated voltage	230 V~
Rated current	6 A
Electrical connection	Connection line, silicone 3 x 1,5 mm ² bzw. 5 x 1,5 mm ² , 1,2 m long, Ø 6-8 mm
Conformity of standards	The equipment meets the technical requirements of the EN 60079-0:2007, EN 60079-1:2007 EN 60079-7:2007 und 60079-18:2004
Feature class	AK4
Type of ignition protection (gas)	EEx emd IIC T3 bzw. T4
EC-type examination certificate	ZELM 03 ATEX 0174X
Identification	<div style="display: flex; align-items: center; gap: 20px;"> <div style="text-align: center;">  0344 </div> <div style="text-align: center;">  II 2 G EEx emd IIC T3 bzw. T4 </div> </div>

1.1 AREA OF APPLICATION

The different electrical heating elements of the type Ex HKA are used for heating cabinets, in particular of instrument protection cabinets.

The heating element is designed for space heating with high specific heat consumption (2W/Liter) at the lowest possible temperature difference in the area. The different internal resistances are provided for series circuit of different heating elements and heat consumptions in constant current systems with 3 A e.g.

For protective cabinet heating of protective cabinets 70I and 150I we offer a system certification. See the manual Ex SSB.

1.2 TEMPERATURE LIMITATION

To what extent the built-in reset limiter can be used as limiter for the complete heating device after setting up the heater, must be determined by a suitable design calculation. In case of doubt an assessment can only be decided by an expert on site. This applies particularly for series-connected, other active components.

1.3 PROTECTIVE MEASURES

As stated in the specifications, a 16 A fuse must be preceded to the heating element. The heater must be connected to the potential compensation. Due to the long supply lines and the resulting capacitive fault currents, which can be increased essentially by humidity saturation of the isolation, residual current circuit breakers with 300 mA are recommended. This advice is based on the fact that, depending on the manufacturer, residual current circuit breakers respond differently at capacitive fault currents.

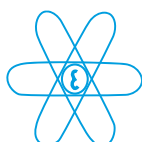

2.1 TABLE 1

Internal resistance	Rated current	Rated operating voltage
Ohm	Ampère	Volt
130	1,8	230
105	1,9	200 (230*)
80	2,2	180
33	3,4	115
20	4,4	90

* max. power surge (4sec.), no continuous operation

3.0 SERIAL NUMBER

xxxx / 03.03

Year
Month
Serial number

3.1 ORDER REFERENCE

EX HKA 1 / **100AT** 2 3 4

1	-	Internal resistance (see table 1, chapter 2.1)
----------	---	--

2	-	Temperature report by guard (see table 2)
----------	---	---

3	-	standard
	s	with protective sleeve
	T	with Teflon coating
	sT	with protective sleeve and Teflon coating

4	-	T3 model
	4	T4 model

Table 1

Internal resistance in Ohm	130	105	80	33	20
----------------------------	-----	-----	----	----	----

Table 2

Temperature guard in °C	5	10	20	40
-------------------------	---	----	----	----

Example: Device with internal resistance of 130 Ohm, 5°C temperature guard, no protective sleeve, T4 model:

ExHKA 130 / **100 AT** 5 - 4
1 2 3 4

4.0 INSTALLATION

1. If the connecting cable has no additional protection, no metal part of the heater or another object may be placed on the connecting cable (This applies for storage and transport).

2. The heater may not be carried on the connecting cable.

3. The installation should always be horizontal: With vertical installation the connection must be running sideways.

4. Due to the max. power of the Ex HKA of approx. 370 W at intended use the max. temperature in the protective cabinet can at known thermal room boundary conditions be estimated. In case of doubt, on site measurements are advisable. In normal operation 100°C can not be exceeded, if no other heating elements exist. Heat losses and further temperature limiters normally lead to significantly lower temperatures within the switching cabinet than the stated value.

5. It has to be checked, if at a max. ambient temperature of the protective cabinet this and other installations are exposed to overheating due to the achievable internal temperature. The indications for the maximum ambient temperature of the used components must be observed.

6. The connection cable must be laid mechanically protected, see also installation material.

7. If the protection cabinet is opened for the purpose of operation, it should be noted that the radiator could be in operation. For this reason the installation of a touch protection for the heater is recommended, or that a sufficient cooling time is observed after switching off.

8. When installed a load of up to 5kg is permitted for the radiator for a short period, if a sufficient assembly is guaranteed.

9. When working on the piping in the protection cabinet, the heater must be removed.

10. No objects may be stored on the heater.

11. Damages or overloads, which result from the connection with other equipment, must be avoided.

5.0 PROJECT (ONLY T3 MODEL)

The radiator itself is limited in its surface temperature.

Concerning the safety, an inadmissible warming which could emanate from the radiator itself is not likely. Functional should be noted, that the maximum introduced power can also be transmitted to the object to be heated most effectively. The installation situation has a significant influence on this. Usually the heat transfer is significantly realized by convection in the protective cabinet. The reasonable conditions for this, as shown in section 5.1, should be respected. Installation situations, such as for example to mount the heater with the narrowest side vertically, lead to a bad heat transfer into the environment. In this situation the supplied power would significantly contribute to heating up of the heater itself, but not cause the desired heating up of the object to be heated. The heating up time of the entire switching cabinet in this case takes longer than in the optimal case. Since the heat transfer only comes to play with adequate temperature differences, the heating rate of the radiator will only at higher temperatures differ significantly from the optimal installation.

It is, accordingly, that the electrical power consumption is primarily responsible for the heat up time of the heater and that the installation situation has less influence. In normal operation the max. surface temperature is at about 100°C. For an optimal warming of the object to be heated, this should possibly be in the convection current of the heater, so that it can flow around optimally. A well isolated cabinet leads to relatively homogeneous temperatures in the switching cabinet after some time. Bad insulated cabinets also show large temperature gradients in continuous duty, which must be observed. A shutdown after reaching the set-temperature can, depending on the permissible max. ambient temperature of the components installed, be rational.

When interconnecting multiple components the electrical data of this manual must also be ensured after the assembly. In particular the default values for voltage and power at the low resistance models are to be considered. For the safety it is advisable, to lay the elements corresponding to the solid shaft power in phase angle controls. An overload or damage of the equipment as a result of this must be avoided.

Often the question is, which temperature allocations adjust within a protective cabinet. Following measurements in a typical installation situation are described.

See table 1 (5.1) and diagram 1 (5.3)

1.)

The ambient temperature around the protective cabinet (150 L uninsulated) has only a quite low influence on the maximum possible power output. The ambient temperature only has an influence on the needed continuous output for the cabinet, in which the measurement is based on a wind speed of 5m/s. In addition it was assumed, that the protective cabinet is equipped with a differential pressure transmitter. The outlet pipes go to the outside uninsulated and the protective cabinet is mounted on a steel construction.

2.)

The surface temperatures as well as the power output change depending on the distance to the wall.

Mounted horizontally the distance between floor and heater was varied between 0 - 100 mm. Mounted vertically the wall distance was varied between 0 - 100 mm.

In dependency of the type of installation and the distance from the wall can thus the discharged power reduction in percent as well as the temperature changes be obtained from the diagram. The influence of the set temperature room thermostat between +10°C and +25°C is shown by the shaded areas. The rated power = max. power at room temperature can be converted accordingly from the table. It can then be determined, up to which max. room temperature the cabinet can be heated up.

3.)

In a first approximation the temperature conditions and the power consumption be converted by means of the surface.

5.1 TABLE 2 (ONLY T3 MODEL)

Power of the Ex HKA in protective cabinet 150L ss at an ambient temperature of -25°C.

Interior temperature	10°C	20°C	30°C	40°C
Required power	120 W	150 W	185 W	225 W
Max. power output of the Ex HKA (leaks)	380 W	330 W	280 W	240 W
Power reserve determines the heating time	68%	54%	34%	6%

5.2 DIAGRAMM 1 (ONLY FOR T3 MODEL)

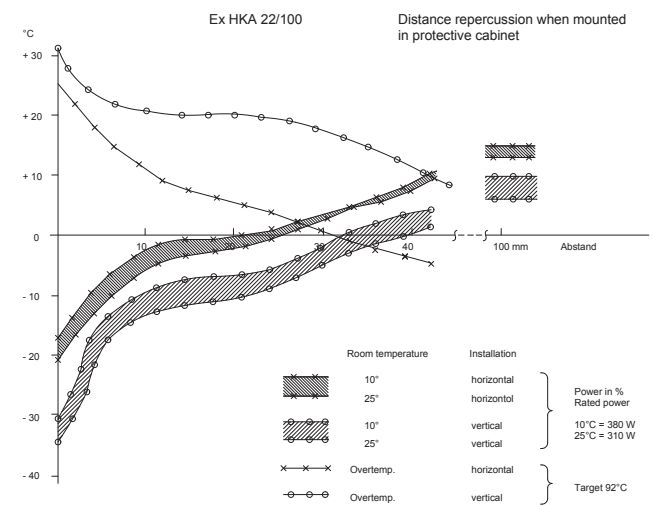

6.0 CONNECTION PLAN

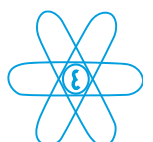
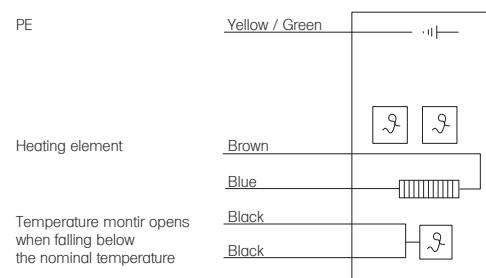

7.0 CABINET CONSTRUCTION AND TEMPERATURE POINTS

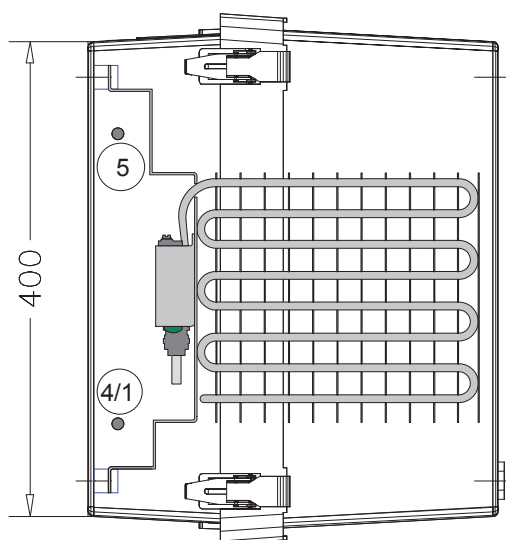
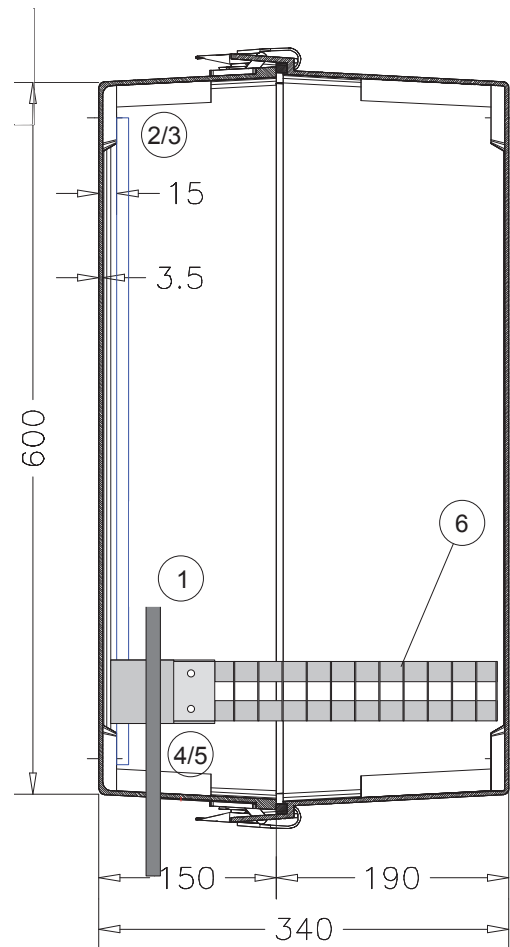
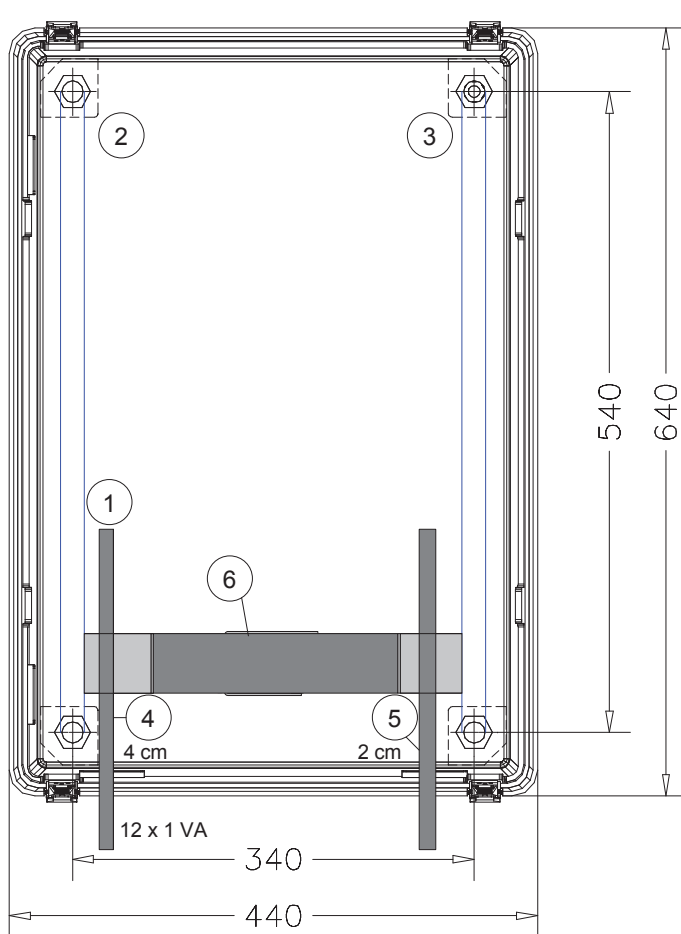
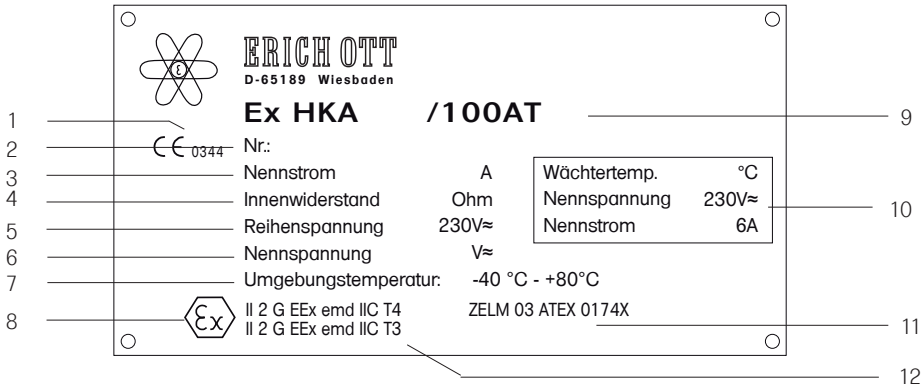

Table 3 (only for T3 model):

Effects of the mounting height of the heater in protective cabinet 150L ss at an ambient temperature of -11°C

Measuring points	Height 4cm	Height 9cm
1	22°C	17°C
2	28°C	33°C
3	28°C	22°C
4	19°C	1°C
5	15°C	-2°C
6	53°C	73°C
N	146 W	146 W

8.0 NAMEPLATE



1-	MONITORED authority	7-	Ambient temperature range
2-	manufacturing number	8-	Ex marking
3-	Rated Current	9-	Type
4-	internal resistance	10-	Guardian characteristics
5-	series voltage	11-	EC-Type Examination Certificate
6-	voltage	12-	Type of protection

9.0 DIMENSIONS

View

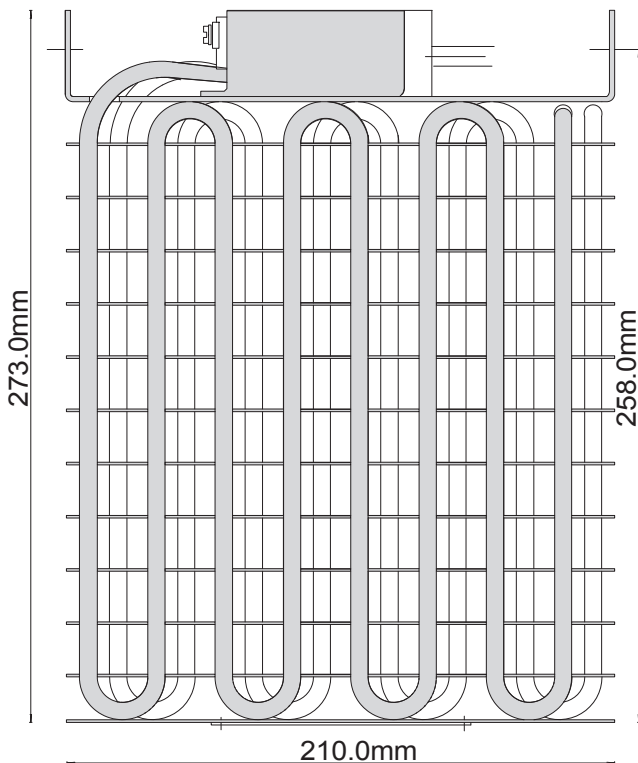

Side view

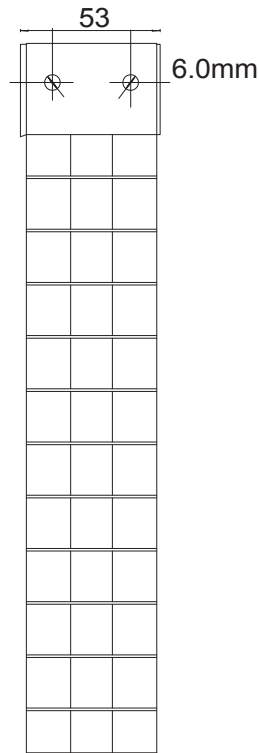

Plan view

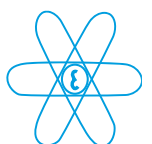
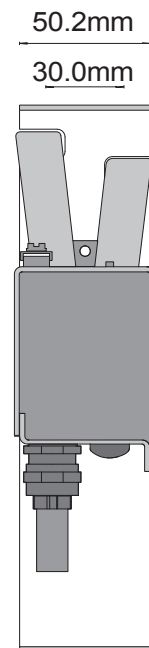

www.erich-ott.de



ERICH OTT 

Erich Ott GmbH & Co. KG
Partner für den Ex-Bereich

D- 65189 Wiesbaden
Rüdigerstrasse 15
Telephone +49 (0) 611 - 76 13 93
Telefax +49 (0) 611 - 71 14 62

mail info@erich-ott.de
web www.erich-ott.de