

EX GH L ALAT

Connection fitting



High-performance connection fitting for mineral isolated cable

GHL

Identification	 II 2G Ex em II II 2D Ex mbD 21
Type examination certificate	ZELM 03 ATEX 0169 U
Ambient temperature	-40°C ... +40°C -40°C ... +80°C
Max. Power	80 W/m 50 W/m
Max. admissible nominal current	16 A / 32A
Nominal voltage	230 V
Degree of protection	IP65

Connection fitting

The connection fittings of the series GHL are used for the connection of mineral isolated heating cables with the power supply in explosive areas. Compared to other variants of the connection fitting of the type GH, this type is suitable for significantly higher maximum length specific power outputs. Furthermore the GHL has a mounting support in form of a screwable termination bolt M24.

For heating systems for the intended use in potentially explosive atmospheres according to Directive 94/9/EC.

TABLE OF CONTENTS

1.0	Description.....	2
2.0	Temperatures at the heating conductor.....	2
2.1	Necessary accessories for connection fitting (GHL)	2
3.0	Technical data.....	2
4.0	Serial Number.....	3
4.1	Order indications.....	3
4.2	Type key	3
4.3	Scope of delivery	3
5.0	General assembly instructions.....	3
5.1	Assembly instructions.....	4
6.0	Casting resin.....	5
7.0	Mounting options.....	5
8.0	Nameplate.....	6
8.1	Completion of the type plate.....	6



Warning

The installation, configuration and commissioning must be carried out only by accordingly trained persons. On-site installation and safety instructions must be observed. Failure to comply assembly and storage requirements will void the warranty and if applicable the certificate level.



Reservation

Technical alteration without prior notice. Changes, errors and typographical errors do not justify any claim for damages. For security components and systems the relevant standards and regulations must be observed as well as the corresponding operating and assembly instructions.

Maintenance

The equipment is maintenance-free if used properly. Cable connectors can be damaged through external influences. Should this lead to a deterioration of the cable connector, the cable connector must be replaced by a re-installation. The dismantling is carried out by cutting off the heat conductor loop. Repair is not possible due to the encapsulation.

Installation notes

The relevant requirements for commissioning/repair/maintenance and testing of the relevant standards of the EN 60079-14, EN 60079-17, EN 61241-14, EN 61241-17, EN 60079-30-1 and EN 60079-30-2 shall be observed, if applicable.

If, during different way of looking at various possibilities of a heat conductor load occur, for safety the highest value of heat output must be assumed. Before commissioning the insulation resistance and dielectric strength of the installation should be reviewed. This requires not through the cable itself, but because of possible



damages to the heat conductor loop or lead-in wire. The requirements of this standard should be examined. If problems still occur during commissioning, we ask you not to make any unauthorized tampering with the device, otherwise the warranty and the validity of the type examination certificate void. Please contact us. In case of service the unit must be returned to us. Please note the additional installation notes on page 3, item 6.0.

Repair

The device is beyond repair.



Please read these operating instructions, before you take the unit into operation. Keep these instructions at a place accessible to all users at all times. Please help us to improve these operating instructions. We are grateful for your suggestions.

Please contact us for technical inquiries!
 Phone: +49 (0)611 761 393
 Fax: +49 (0)611 711 462
 E-Mail: erichott@gmx.de

1.0 DESCRIPTION

Characteristics

No heating necessary for the installation
Fast assembly at site
Pre-assembled compound
Manifold application area due to high heating capacity for all popular MI-cables
Substitutes complex soldering and pre-assembling of MI-cables
Screw or clamp fastening with M24 nut



The supply line is as standard a 1,2 m long , 3-wire cord with 1,5 mm² diameter, which is available with an insulation of PTFE. If desired, other lengths, as well as a larger wire size of 2,5 mm² are available. To ensure a durable and moisture-proof encapsulation, the armature is filled with a special two component polymer sealant, which must be ordered separately. The electrical connection is guaranteed by a specially designed clamp placed in a nickel-plated brass-case (alternatively corrosion inert stainless steel). Both measures provide a highly reliable electrical connection. To attach the connection fitting to a mounting iron or similar, the armature is equipped with a M24 thread and a M24 nut. If the use of a separate PE-connection is necessary, this may be realized by using an appropriate mounting iron. The connection armatures are supplied partially made up. The power cable is firmly connected to the terminal insert and shed in the armature. The remaining assembly steps required for the connection of the heating conductor loop and their encapsulation can be found in the mounting instructions, step 1-8, chapter 5.1.

The connection fitting is suitable for all mineral isolated resistance heat conductors with coaxial structure, which meet the requirements of the EN 60079-7 or the EN 60079-30-1 and comply with this manual. The complete compound is preferably attached directly as a loop outside the insulation or under the insulation on the pipe. In this connection the maximum ambient temperatures of the EC-type examination certificate as well as the instructions in this guide are to be noted. the feeder lines as well as the materials and the length of the loop must be indicated in the product key (see chapter 4.1). The use is still limited by the maximum allowed port valves and maximum allowable surface temperature of the heating element.

3.0 TECHNICAL DATA

Cable diameter	3,2 mm to 5,8 mm	
Core diameter	Min. 0,37 mm	
Max. power dissipation per m heating cable:	80 W/m (bei +40°C ambient temperature)	
Supply voltage	230 V DC or AC voltage	
Max. admissible current	16 A or 32 A	
Connecting cable	1,5 mm ² (16 A) or 2,5 mm ² (32 A) PTFE or Silikon	
Degree of protection	IP65 / DIN EN 60529	
Measures GHL	100 x 32 mm	
Mounting hole	26 mm	
Temperature at connection armature GHL	max. 180°C (point 2.0)	
EC-type examination certificate	ZELM 03 ATEX 0169 U	
Type of protection (Gas)	Ex em II	
Type of protection (Dust)	Ex mbD 21	
Marking	CE 0344	 II 2G Ex em II II 2D Ex mbD 21

2.0 TEMPERATURES AT THE HEATING CONDUCTORS

T3 (Gas), bzw. 180°C (Dust)	
Temperature	Capacity
-40 °C .. +40 °C	80 W/m
-40 °C .. +60 °C	65 W/m
-40 °C .. +80 °C	50 W/m

T4 (Gas), bzw. 130°C (Dust)	
Temperature	Capacity
-40 °C .. +40 °C	45 W/m
-40 °C .. +60 °C	30 W/m
-40 °C .. +80 °C	20 W/m

The temperature of the heater circuit is not defined by the cable connector but by the power loss of the connected heating cable and its diameter. Accordingly, the mounting place of the connection armature must be chosen depending on the application. (See assembly specifications for the heater circuit, chapter 5). It should be considered that the max. surface temperature at a given heating power is depending on the heat conduction and the ambient temperature. Temperature under isolation will extremely exceed those of free convection for which the power data is calculated. .

Safety relevant is the max. surface temperature of the connection fitting of 180°C. Considering the mounting instructions in accordance with point 7.0 and adhering to the maximum ambient temperatures specified in point 2.0, the compliance with the safety relevant temperature is ensured.. If the installation guidelines can not be met, the surface temperature of the connection fitting must be checked.

2.1 NECESSARY ACCESSORIES FOR CONNECTION ARMATURE CASTING RESIN (GHL)

The cast resin is subject to shelf life and must accordingly be ordered with a separate number. However, it is mandatory to use, otherwise the certificate level extinguishes. After having ordered, the resin must be used within 6 months. The instructions for the processing must be considered. The certification is only valid when using the above resins, used as intended and properly fitted. The resin is suitable up to 80 W/m and a maximum surface temperature of 180 °C.

Please take further information from the resin data sheet.

Download on www.erich-ott.de.

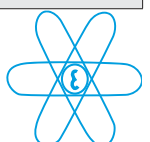

4.0 PRODUCTION NUMBER

xxx / 03.03

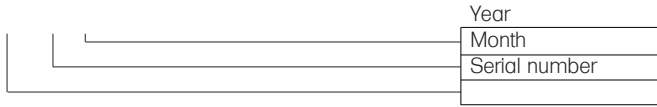

4.1 ORDERING INFORMATION

The type code is the complete ordering information excluding the length of the connection cable. The standard length of the loop is 1,2 m. Other lengths must be indicated in plain text. The grout (resin) must be ordered separately.

4.2 TYPE KEY

EX GH L ALAT 1 2 3 4 5

1	-	Standard connection 1,5 mm ²
	32A	Connection cable 2,5 mm ²
2	-	Standard design
	S	with protection hose stainless steel A2
3	P	Connection cable PTFE
	S	Connection cable Silicone
4	-	Standard
	VA	Execution „stainless steel“
5	-	Standard length connection cable: 1,2 m
	...	Length in plain text, (Possible lengths: 0,5 - 5 m)

Example: Device with standard connection 1,5 mm², standard protection hose, cord made of PTFE, design „stainless steel“ length of connection cable 1,2 m.

EX GH L ALAT 1 2 3 P VA 5



Regard! The casting resin must be ordered separately, see ordering information sheet resin.

4.3 SCOPE OF DELIVERY

Connection armature

1. Clamp body with preassembled connection cable
2. Sleeve
3. Strain relief with dental disc
4. Scraw and securing device
5. O-Ring and nut M 24x1,5
6. Type plate

5.0 GENERAL ASSEMBLY INSTRUCTIONS

It shall be secured that the legal and other regulations according to the assembly of heat tracings are observed. If used in potentially explosive atmospheres the construction regulations of EN 60079 - 14, 61241 - 14 shall be observed. The information and requirements of the EN 62086-1 and 62086-2 shall be observed too, when appropriate. The cable ends are intended for connection in the type of protection „increased safety“. When connecting the armature in potentially explosive atmospheres caused by dust it shall be kept in mind, that the connection has to fulfill the requirements of the corresponding zone. When connected in environments with combustible dust, it is to be noted that the final connection is enough to at least the degree of protection IP 54 in zone 22 and IP 6x in zone 21.

Up to 16 A the standard 1,5 mm² connection cable can be selected. Above these services the 2,5 mm² variant must be chosen. For the loop variants in silicone and PTFE are available, for both cross-sections. Furthermore, the possibility of sleeve body made of high chrome-nickel steel is preserved. For the connection cable a protection can be purchased as well..

In case of an amendment of the strain relief skp at a diameter of $\geq 3,5$ mm proceed as follows: the strain relief skip must be adjusted to the radius of the heating cable with an accuracy of $\pm 0,3$ mm. If two strain reliefs must be changed equally, it is recommended after removing the pressure plate, to harness both strain reliefs against each other and to drill the hereby emerging drill-hole to the heating cable diameter .

If humidity should occur in the heat conductor and therefore the insulation resistance decrease, the isolation is also physically damaged. In this case a complete replacement of the loop is recommended.

The connected heating elements must be laid parallel to the connector. To lay the wires close to the housing must generally be avoided..

External stresses shall be avoided in particular during the transport and storage. All parts of the connection armature shall be checked up on damages before assembly. Do not assemble if damages have been detected.

5.1 INSTALLATION INSTRUCTIONS

The length of the heating coil (cable) has to be 400 mm longer than the calculated length. The length needed within the connection armature has to be added. The remaining cable should be sealed with special growth. In the case that the heating coil is not assembled just in time, the heating coil has to be sealed, too. These dimensions must be taken into account when planning. The connection cable must be laid mechanically protected.

In case of high humidity isolation resistance may decrease up to one order of magnitude within 2 minutes after cutting. Because of those facts manufacture shall not be performed if humidity exceeds 75%. The isolation value shall be higher than 50 MΩ after installation. For longer lines the recommended insulation value of $\geq 50 \text{ M}\Omega$ can not be reliably be determined. There are however higher demands on the resistance in this case. Please consider the relevant standards EN 62086-1 and EN 62086-2. In case of mineral isolated heating coils the isolation resistance shall be measured with 1000 V AC. The dielectric strength shall be detected with $1000 \text{ V} + 2 \cdot U_{\text{Nenn}}$. Test durations shall be 1 minute sinusoidal between 45 Hz und 64 Hz. In case of doubt apply the standards referred to in the installation instructions as well as the EN 60079-17 and EN 61241-17.

The strain relief has two semi circle cut outs which are suitable for heating coils up to 3,3 mm in diameter. With larger diameter of the heating cable the recess must be adapted accordingly. Cut both ends of the heating cable by 200 mm. Clean the end standing 50 mm with emery cloth or similar and remove 16 mm of the isolation.. Burr formati-on shall be removed with scribe. If you can not place the heat conductor loop to harden with the opening facing up, you should proceed as follows:

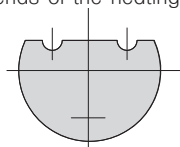

Figure 1: Strain relief skip

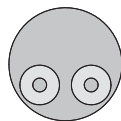

Figure 2 for Step 1: Cap with silicone spout

Step 1: First push the silicone seal inserts in the milled screw, as shown in figure 2.. The main length of the insert must face outwards. Then push the mounted milled screw over the heat conductor.

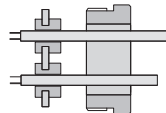

Figure 3 for Step 1: Thumbscrew and cap

Step 2: Then clamp both ends of the heating coil, so that 2mm of the jacket are still visible. The strain relief realizes the PE-connection of the MI-cable with the connection lead and the cabinet at the same time.

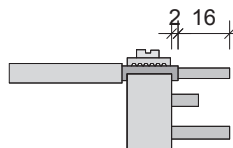

Figure 4 for Step 2: Strain relief

Step 3: Move the threaded sleeve in the direction of the hose line over the heating cable.



Figure 5 for Step 3: Strain relief and shell

Step 4: Connect heating cable and strain relief to the clamp body. (The inner wire of the heating cable should be visible through the control bore.)

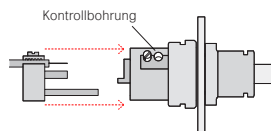

Figure 6 for Step 4: Screw on heating element

Step 5: Screw the sleeve on the pre-assembled connection armature.

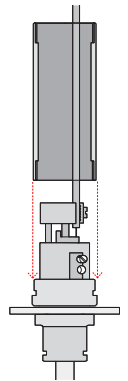

Figure 7 for Step 5 : Clamp body

Step 6: Check, if there is no short circuit between the wires or wire and housing. The requirements of the corresponding standards concerning isolation resistance and dielectric strength shall be fulfilled. Idea behind those tests is to control the correct installation of the electric installation of the heating coil.

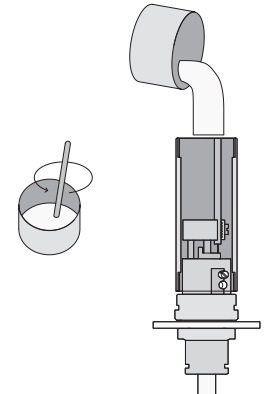

Figure 8+9 for Step 7 : Mixing and pouring of the casting resin

Step 7: Mix the cast resin 2855 -T125L by considering the pre-processing instructions for the resin.. Handling temperature and the hints to the maximum humidity shall be observed. Please fill the grout slantwise to avoid including air during the shedding.

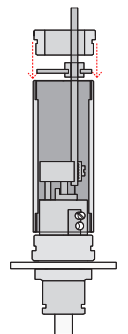

Figure 10 for Step 8: Connector with housing

Step 8: Before screwing the cable connector with milled screw, the grout should rest in a vertical position for approx. 5 minutes to let escape possible air entrapments.

Complete the data of the type plate:

- The nominal voltage* refers only to the heating cable and has to be calculated.
- Nominal current (Operating current)
- Type of heating cable**

* It should be kept in mind, that the effective voltage may be lower than the nominal voltage due to existing inductances and capacitances. The kind of installation may have an influence on those parameters, too. Safety relevant is the nominal value but for dimensioning the effective value is the interesting one.

** The type of heating coil must include information to length and specific resistance of the heating coil.



Bild 11: fertig montiertes Gerät



6.0 CASTING RESIN

Cast resin set : 2855-T125L

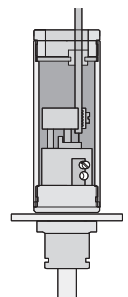
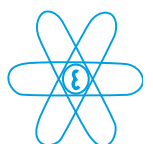
Hint: Not included. Please take further information from the datasheet 2855-T125L

1. Scope of delivery: 1 tin component „A“, 1 cannula component „B“, 1 wooden spatula
2. Storage: The date of expiry requires a vertical storage and storage temperature lower than 23°C. The integrity of the set can be checked by observing the information given in point 3. and 4..
3. Processing conditions: The pot life at 23°C is approx. 30 min. If the compound hardens at a temperature at 10°C higher, the curing time is halved. The hardening time at ambient temperature is 16 hours. Commissioning before curing is not allowed, Otherwise the guaranteed properties can not be met.
4. Use: Open tin „A“. Stir contents well with the enclosed wooden spatula if the floor is paste-set, until a homogeneous liquid is present (it should not form any clumps). Open cannula „B“ and pour in tin „A“. Mix by stirring with spatula (at least 1 ½ minutes), the stirring of air must be avoided. The finished resin can be poured within the pot-life into the pre-assembled connection sleeve.
Notes: The adhesive irritates eyes and skin. Sensitization by skin contact possible. For more information please see the data sheet for the grout.
* If the sediment can no longer be stirred, never lift off the precipitation but scratch it layer by layer and mix between each layer. Does it take longer than 15 minutes to get a homogenous fluid of substance „A“, the substance must be disposed.

The use is still limited by the maximum allowed port values and the maximum allowable surface temperature on the heating element.

Therefore also see the datasheet for the resin.

7.0 MOUNTING OPTIONS

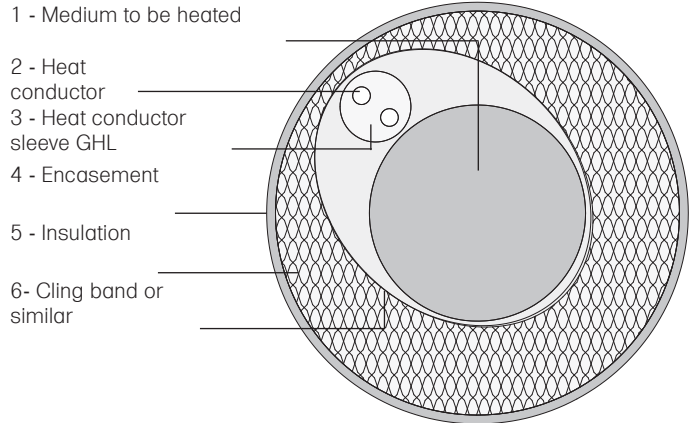
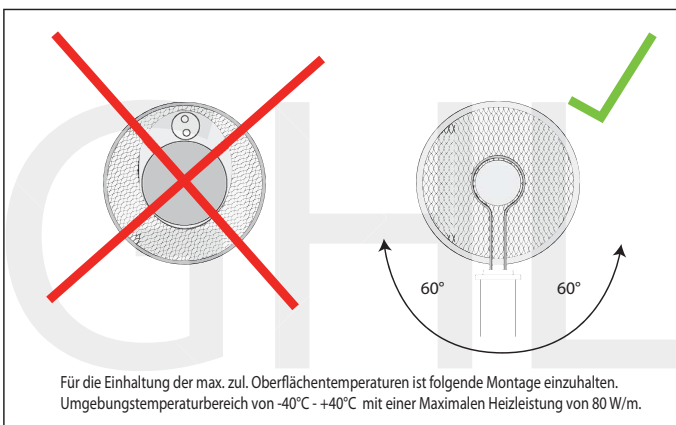

Regard! Maximum surface temperature of the heat conductor sleeve inside the encasement

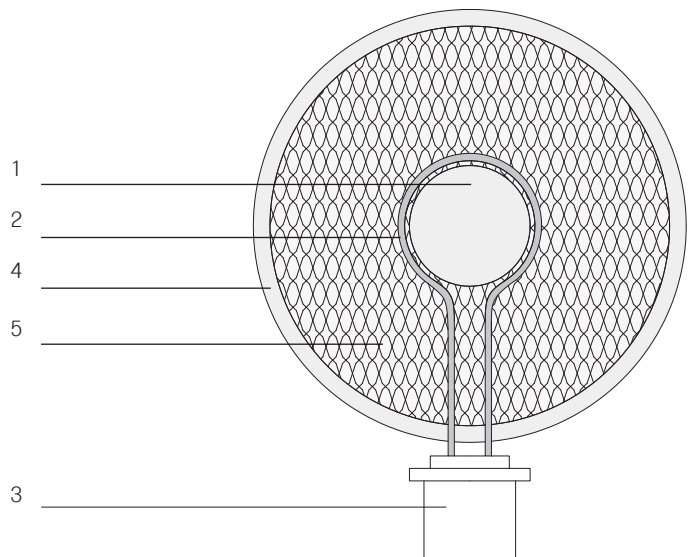
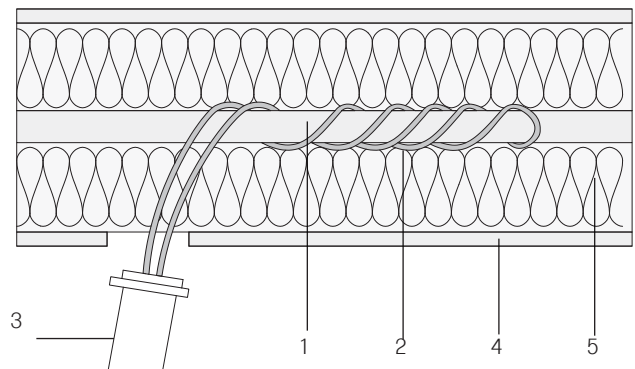

outside the encasement

Note: The heating cable must be connected flush with the medium to be heated.



Regard ! At maximum heatoutput the temperatures at the heat conductor sleeve can cause burns. Look for shock protection. Not included.

8.0 NAMEPLATE

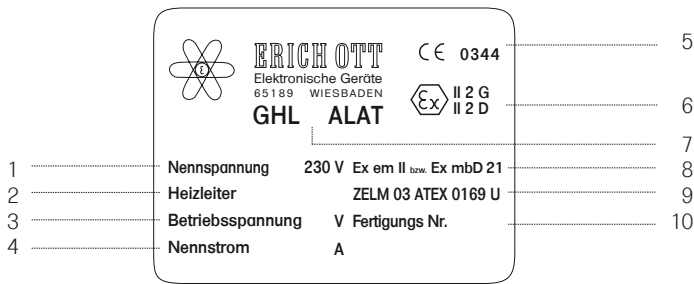

1-	Nominal voltage	6-	Ex- labelling
2-	Heat conductor	7-	Type name
3-	Rated Voltage	8-	Type of protection
4-	Rated current	9-	Inspection authority/ EC-type examination certificate
5-	Supervising agency	10-	Serial number

8.1 COMPLETION OF THE TYPE PLATE

The type plate is a multi-layer design with extreme adhesiveness. For this reason a revision after gluing is impossible. Little bubbles or waves can not be removed after improper gluing. In the state of delivery the type plate has a laminate foil which cannot be removed after assembly. Flatten the foil from the connection to the open end and take care of bubbles and waves. After that preparation the type plate is resistant to most chemicals. Before flattening the laminale foil, the type plate can be labelled with a lightfast pencil. Delivery condition is a labelling with production number. After the assembly of the cable connector the following values must be filled in by the engineer:

Type of heating coil*
 Nominal voltage
 Nominal current

After that the folding lamination must be closed.

* The type coil must include information about length and specific resistance of the heating coil.

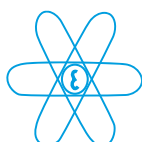

www.erich-ott.de



ERICH OTT 

Elektronische Geräte
Inh. Barica Ott

D- 65189 Wiesbaden
Rüdigerstrasse 15
Telefon +49 (0) 611 - 76 13 93
Telefax +49 (0) 611 - 71 14 62

mail erichott@gmx.de
web www.erich-ott.de