

## EX GH ... ALAT

Connection fitting



Identification	 II 2G Ex em II II 2D Ex mbD 21
Type examination certificate	<b>ZELM 03 ATEX 0169 U</b>
Ambient temperature	<b>-20°C bis +70°C</b>
Heater power	<b>22 W/ m</b>
Max. admissible nominal current	<b>18A</b>
Nominal voltage	<b>230 V/ 400 V</b>
Degree of protection	<b>IP65</b>

### Connection armature

Connection fitting for the connection of a heat conductor loop in the hazardous area.

Fast and cost minimizing due to location assembly and cold rugged stain.

Advantageous here: Heating begins at the pipe, connection armature is strapped on the pipe. This creates no heat loss in the air between socket and pipe, transition piece between the protection of loads to be heated and pressure lines.

For heating systems for intended use in potentially explosive atmospheres according to Directive 2014/34/EU.

Connection fitting for mineral isolated cables	GH
Connection fitting for plastic isolated cables	GHT
Connection fitting for parallel heating elements	GHP

## INHALTSVERZEICHNIS

1.0	DESCRIPTION.....	2
2.0	NECESSARY ACCESSORIES FOR CONNECTION FITTING (GH/ GHT/ GHP).....	2
3.0	TECHNICAL DATA.....	2
4.0	PRODUCTION NUMBER.....	3
4.1	ORDERING INFORMATION.....	3
4.2	TYPE KEY .....	3
4.3	SCOPE OF DELIVERY .....	3
5.0	TEMPERATURES AT THE HEAT CONDUCTOR .....	3
6.0	GENERAL ASSEMBLY INSTRUCTIONS.....	3
6.1	ASSEMBLY INSTRUCTIONS FOR MINERAL ISOLATED HEATING CABLE GH.....	4
6.2	ASSEMBLY INSTRUCTIONS FOR PTFE ISOLATED HEATING CABLE GHT.....	5
6.3	ASSEMBLY INSTRUCTIONS FOR PARALLEL HEATING BAND GHP.....	5
7.0	MOUNTING OPTIONS FOR GH AND GHT.....	6
8.0	CASTING RESIN.....	6
9.0	NAMEPLATE .....	6
9.1	COMPLETION OF THE NAMEPLATE.....	back
10.0	DIMENSIONS .....	back
10.1	VARIATIONS .....	back



### Warning

The installation, configuration and commissioning must be carried out only by trained persons. On-site installation and safety instructions must be observed. Failure to comply assembly and storage requirements will void the warranty and if applicable the certificate level. If, during different way of looking at various possibilities of a heat conductor load, for safety the highest value of heat output must be assumed.



### Reservation

Technical alteration without prior notice. Changes, errors and typographical errors do not justify any claim for damages. For security components and systems the relevant standards and regulations must be observed as well as the corresponding operating and assembly instructions.

### Maintenance

The equipment is maintenance-free if used properly. Cable connectors can be damaged through external influences. Should this lead to a deterioration of the cable connector, the cable connector must be replaced by a re-installation.

### Installation notes



The relevant requirements for commissioning/ repair/ maintenance and testing of the relevant standards of the EN 60079-14, EN 60079-17, EN 61241-14, EN 61241-17, EN 60079-30-1 and EN 60079-30-2, if applicable, shall be observed. The equipment is maintenance-free if used properly. Cable connectors can be damaged through external influences. Should this lead to a deterioration of the connector, it must be replaced by a re-installation. Therefore simply cut off the heating cable at the entrance of the connection armature. Because of the type of protection encapsulation repair is impossible.

When heating coils with PTFE are used, please keep in mind that this material has a distinctive cold flow behavior. This has no influence on the connection armature itself but may lead to a decrease in safety relevant parameters e.g. insulation or dielectric strength over time. Depending on the foreseen conditions a check of those values after an adequate time may be recommended.

If problems still occur during commissioning, we ask you not to make any unauthorized tampering with the device, otherwise the warranty and the validity of the type examination certificate void.

### Repair

The device is beyond repair.



Please read these operating instructions, before you take the unit into operation. Keep these instructions at a place accessible to all users at all times. Please help us to improve these operating instructions. We are grateful for your suggestions.

Please contact us for technical inquiries!

TELEFON: +49 (0)611 761 393

TELEFAX: +49 (0)611 711 462

E-Mail: info@erich-ott.de

## 1.0 DESCRIPTION

### Features

- Connection sleeve for all common types of heating conductors
- Easy installation
- No heating necessary
- In use since more than 20 years
- Ready-made grout
- Screw or clamp fixing with M24 nut



The following connection armatures are used to connect different types of heating conductors with energy in explosive areas. Depending on the type of heating cable one of the following variants is eligible:

1. Type GH for mineral isolated (MI) heating cables
2. Type GHT für PTFE- isolated heating cables
3. Type GHP für parallel heating cable including termination fitting

All variants are equipped with 3-wire connection, although these standard are delivered with EVA-insulation, 1,2m length and 1,5mm<sup>2</sup> cross-section. For special requirements both, silicone and PTFE insulators are available. All versions are also available with a protective tube made of stainless steel. If desired, other lengths, as well as a larger wire size of 2,5mm<sup>2</sup> are available. To ensure a durable and moisture-proof encapsulation, the armature is filled with a special two component polymer sealant, which must be ordered separately. The electrical connection is guaranteed fixed by a specially designed clamp in a nickel-plated brass-case (alternatively corrosion inert stainless steel. Both measures provide a highly reliable electrical connection. To attach the connecton armature to a mounting iron or similar, the armature is equipped with a M24 thread and a M24 nut. If the use of a sepearate PE-connection is necessary, this may be realized by using an appropriate mounting iron.

The connection armatures are supplied partially made up. The power cable is firmly connected to the terminal insert and poured in the armature. The remaining assembly steps required for the connection of the heating conductor loop and their encapsulation can be found in the mounting instructions, chapter 6.1 - 6.3. The connection armature is suitable for all mineral isolated resistance heat conductors with coaxial structure, which meet the requirements of the EN 60079-7 or the EN 60079-30-1 and comply with this manual. The complete connection is preferably attached directly as a loop outside the insulation or under the insulation on the pipeline. In this connection the maximum ambient temperatures of the EC-type examination certificate as well as the instructions in this operating manual are to be noted.

The feeder lines as well as the materials and the length of the loop must be indicated in the product key (see chapter 4.1).

Available cable diameters:



Cable type	Current	
	16 A	18 A
EVA	1,5 mm <sup>2</sup>	1,5 mm <sup>2</sup>
PTFE	1,5 mm <sup>2</sup>	2,5 mm <sup>2</sup>
Silikon	1,5 mm <sup>2</sup>	2,5 mm <sup>2</sup>

## 2.0 NECESSARY ACCESSORIES FOR CONNECTION FITTING CASTING RESIN (GH/GHT/GHP)

Cast resin 2855-T125. This is subject to shelf life and must be ordered in accordance with a separate number. However, it is mandatory to use, otherwise the comprehension of the certificate extinguishes. After having ordered, the resin must be used within 3 months. The instructions for the preparation must be considered. The authorization is only valid when the above mentioned resins are used as intended and properly fitted. The cast resin 2855-T125 is only suitable up to 22 W/m and at a maximum surface temperature of 70°C.

Please take further information from the resin sheet. Download at [www.erich-ott.de](http://www.erich-ott.de).

## 3.0 TECHNICAL DATA

Cable diameter	3,0 mm bis 5,8 mm	
Max. power dissipation per m heating cable: Cast resin armature (GH/ GHP) (GHT)	22 W/m (at +40°C ambient temperature) 15 W/m (at +40°C ambient temperature)	
Current type	DC or AC voltage	
Supply voltage of the connector	230/ 400 V	
Max. admissible current	18 A	
Connecting cable	1,5 mm <sup>2</sup> oder 2,5 mm <sup>2</sup> EVA, PTFE or silicone	
Degree of protection	IP65/ DIN 40 0 50	
Measures: GH/ GHP GHT	85 x 32 mm 100 x 32 mm	
Mounting hole	26 mm	
Temperature at connection fitting GH	max. 70°C (applies at max. power dissipation at the inlet of the heat conductor to the resin)	
Ambient temperature	-20°C bis +40°C +60°C at accordingly adapted heat output	
EC-type examination certificate	ZELM 03 ATEX 0169 U	
Type of protection (gas)	Ex em II	
Type of protection (dust)	Ex mbD 21	
Identification	 0344	 II 2G Ex em II II 2D Ex mbD 21

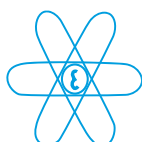

## 4.0 PRODUCTION NUMBER

xxxx / 03.03

	Year
	Month
	Serial number

## 4.1 ORDERING INFORMATION

The type code is the complete ordering information excluding the length of the connection cable. The standard length of the loop is 1,2m. Other lengths must be indicated in plain text. The grout (resin) must be ordered separately.

## 4.2 TYPE CODE

ExGH 

1
---

 ALAT 

2
---

3
---

4
---

5
---

1	-	For mineral isolated heating cable
	T	For PTFE isolated heating cable
	P	For parallel heating elements
2	-	Standard connection cable 1,5 mm <sup>2</sup> 230V
	400	Connection cable 2,5 mm <sup>2</sup> 400V
3	-	Standard version
	S	With stainless steel A2
	M	Single connector (Sleeve)
	PE	Terminal box polyester
	VM	Connection sleeve with 2 connection sleeves
4	-	Standard Connection cable (EVA) bis110°C 1,5 mm <sup>2</sup>
	P	Connection cable PTFE 1,5 mm <sup>2</sup>
	P 2,5	Connection cable PTFE 2,5 mm <sup>2</sup>
	S	Connection cable Silicone 1,5 mm <sup>2</sup>
	S 2,5	Connection cable Silicone 2,5 mm <sup>2</sup>
5	-	Standard
	va	Execution „stainless steel“
6	-	Standard length connection cable: 1,2 m
	...	Length in plain text, (Possible lengths: 0,5 - 5 m)

Example: Device GHT with PTFE-isolated-heating-cable, standard protection hose, cord made of PTFE, execution stainless steel, length of connection cable 1,2m

ExGH 

T
---

 ALAT 

1
---

2
---

3
---

VA
----

5
---



Attention! The casting resin must be ordered separately, see ordering information sheet resin.

## 4.3 SCOPE OF DELIVERY

### Connection armature

1. Terminal block with preassembled connection cable
2. Sleeve
3. Strain relief with tooth lock washer
4. Screw and loss protection
5. O-Ring and nut M24x1,5
6. Nameplate
7. Hose clamp with protective hose (2-fold) (GHT and GHP only)

## 5.0 TEMPERATURES AT THE HEAT CONDUCTOR

### GH and GHT

The temperature of the heater circuit is not defined by the cable connector but by the power loss of the connected heating cable and its diameter. Accordingly, the mounting place of the connection armature must be chosen depending on the application. (See assembly specifications for the heater circuit.) It should be considered that the max. surface temperature at a given heating power is depending on the heat conduction and the ambient temperature. Temperature under isolation will extremely exceed those of free convection for which the power data is calculated. Safety relevant is the max. surface temperature of 70°C for the connection armature. This temperature is not exceeded if an ambient temperature of +40°C is present and a heating power of 22 W/m is not exceeded. If higher heating powers are wanted, the ambient temperature must be lower. If higher ambient temperatures are present the max. heating power has to be reduced so that the max. allowable surface temperature of 70°C is not exceeded. Some typical combinations of heating power and cable diameter which fulfill the safety relevant parameters are mentioned in the EC-type examination certificate ZELM 03 ATEX 0169 U.

### GHP

The maximum temperature is directly defined by the used cable type. The design determines a self regulating maximum surface temperature which is independent of the max. transient power consumption. In contrary to coaxial heating cable the use of ground fault circuit interrupters, an adequate fuse or a temperature sensor will not lead to a detection of a failure in the heating circuit. Result is that the safety relevant situation of a heating circuit with self regulating heating bands is only easy to determine in normal use. If the heating circuit is damaged and this damage does not lead to a direct interruption every possible failure situation may appear. We recommend the use of this type of heating conductor only in hazardous areas of zone 2 or 22.

## 6.0 GENERAL ASSEMBLY INSTRUCTIONS

It shall be secured that the legal and other regulations according to the assembly of heat tracings are observed. If used in potentially explosive atmospheres the construction regulations of EN 60079-14 or 61241-14 shall be observed. The information and requirements of EN 62086-1 and 62086-2 shall be observed too, when appropriate. The cable ends are intended for connection in the type of protection „increased safety“. When connecting the armature in potentially explosive atmospheres caused by dust it shall be kept in mind, that the connection has to fulfill the requirement of the corresponding zone. When connected in environments with combustible dust, it is to be noted that the final connection is enough to at least the degree of protection IP 54 in zone 22 and IP 6x in zone 21. Connecting cables with a diameter of 1,5mm<sup>2</sup> should be used if connecting powers do not exceed 3,6 kW. If higher connecting powers are wanted, please order connecting cables with 2,5 mm<sup>2</sup> diameter. Depending on temperature and environmental conditions the use of the standard material PVC may not be adequate. For those cases for both cross-sections two other cable materials (PTFE and silicone) are available. Further on you have the possibility to order a high alloyed stainless steel sleeve. For the connection cable a stainless steel hose is available, too. In case of using heating coils with diameters bigger than 3,5mm<sup>2</sup> the strain relief tray has to be fitted to the bigger diameter. The new strain relief tray diameter shall be -0,3mm of the connected heating coil. When two strain reliefs shall be fitted it may be useful to mount them in such way, that the trays of both form one hole. Before this is possible, please remove the two toothed pressure plates. If humidity may be detected within the heating coil because of too low insulating resistance we recommend to replace the whole heating coil. The two heating coils (cables) shall be mounted parallel around the connecting armature. The elements shall not be in contact to the housing. External stresses shall be avoided in particular during transport and storage. All parts of the connection armature shall be checked up on damages before assembly. Do not assemble if damages have been detected.

## 6.1 ASSEMBLY INSTRUCTIONS FOR MINERAL ISOLATED HEATING CABLE GH

**Step 1:** The length of the heating coil (cable) has to be 400mm longer than the calculated length. The length needed within the connection armature has to be added, too. Remaining cable should be sealed to avoid humidity within the cable. In the case of assembling the heating coil not just in time, the heating coil has to be sealed, too. The given lengths have to be added to the calculated heating coil length to avoid problems during assembly. The connection cable shall be laid protected.

**Step 2:** In case of high humidity isolation resistance may decrease up to one order of magnitude within 2 minutes after cutting. Because of those facts manufacture shall not be performed if humidity exceeds 75%. The isolation value shall be higher than  $50M\Omega$  after installation. If heating coils are very long the measurement of the isolation resistance may not be very reliable. In those cases the requirements are different. Please consider the relevant standards EN 62086-1 and EN 62086-2. In case of mineral isolated heating coils the isolation resistance shall be measured with 1000 V AC. In case of PTFE isolated heating coils this value should be 2500 V AC. the dielectric strength shall be detected with  $1000 V + 2 * U_{Nenn}$ . Test durations shall be 1 minute sinusoidal between 45 Hz and 64 Hz. When in doubt apply the standards referred to in the installation instruction as well as the EN 60079-17 and EN 61241-17.

**Step 3:** The strain relief has two semi-circle cut outs which, if not ordered differently, are suitable for heating cables with a diameter of up to 3,3 mm. For larger diameters the cut-out must be accordingly adapted.

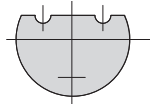

Picture 1 for Step 3: Strain relief skip

**Step 4:** Shorten both ends of of the heating cable by 200mm and clean at a length of 50mm by use of a emery cloth, strip 16mm. Remove burr formation by use of a scribing iron.

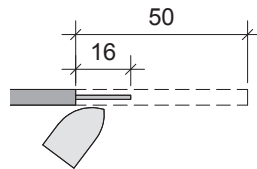

Picture 2 for Step 4: Shortening the heating cable

**Step 5:** Trap both ends of the heating cable so that 2 mm of the jacket are still visible. The strain relief realizes the PE-connection of the MI-cable with the connection cable and the cabinet.

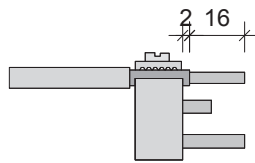

Picture 3 for Step 5: Strain relief

**Step 6:** Move the sleeve with thread in direction of the hose line over the heating cable.



Picture 4 for Step 6: Sleeve

**Step 7:** Connect the circuit and the strain relief in the terminal block. (The conductor ends must be visible through the control bore.)

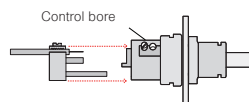

Picture 5 for Step 7: Sprag

**Step 8:** Screw the sleeve on feed-through bolt.

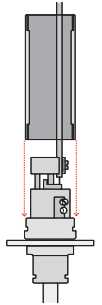

Picture 6 for Step 8: Connector with cabinet

**Step 9:** Check, if there is no short-circuit between the conductors or conductor and cabinet. The requirements of the corresponding standards concerning isolation resistance and dielectric strength must be checked after the installation (to preclude damages at the heating cable after the installation).

**Step 10:** Mix resin 2855-T125 Observe the processing instructions of the resin. It is important to consider the processing temperature and the hints for max. humidity.

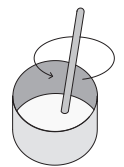

Picture 7 for Step 10: Resin

**Step 11:** Fill resin into the sleeve.

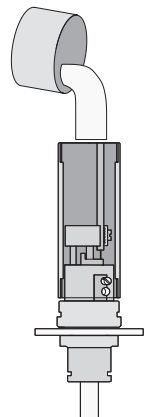

Picture 8 for Step 11: Pour into the sleeve

**Step 12:** Complete the data of the nameplate:

- a The nominal voltage\* only refers to the terminal connection and must be calculated
- b Nominal current (Operating current)
- c Type of heating cable\*\*

\* It should be kept in mind that, depending on the length of the heating cable, measurable inductivities and capacities can result. The type of installation can also lead to influences. The consequence is, that the effective capacity is lower than the normal capacity. Safety relevant is the nominal voltage, whereas concerning the design, the effective voltage must be applied for the power determination.

\*\* The type designation must indicate length specific resistance and real length.

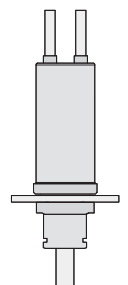

Picture 9: Ready mounted device

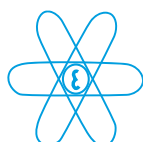

**6.2 ASSEMBLY INSTRUCTIONS FOR PTFE ISOLATED HEATING CABLE GHT**

The cold flow behavior, resp. viscosity in PTFE cables decreases by the factor of ten per 10°C warming. The PTFE cable shall be laid twist-free and without tensile stress (<1Kg) if continuous temperatures of over 80°C are wanted. Keep in mind that the temperature at the connection armature may be totally different to the situation under isolation. Further information given by the heating cable manufacturer to loading tolerance in dependence to the ambient temperature shall be observed.

**Step 1:** See 6.1 Step 1

**Step 2:** See 6.1 Step 2

**Step 3:** Shorten the mounting protection of the heating coil to a length of 100mm, the outer isolation to a length of 44mm and remove the shielding on a length of 30mm. Do not cut the shielding. Other elements as e.g. glass fiber bandages should be removed. Roughen all isolating surfaces for a total length of 65mm.

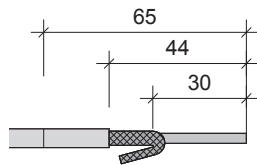

Picture 1 for Step 3: Heating coil

**Step 4:** Push a cable protective tube over both ends of the heating coil and fix them with an O-ring clamp at a distance of 63mm from the end of the shielding of the heating coil. Align the end of the shielding along the cable conductor. Clamp both ends of the heating coils under the strain relief. A distance of 32mm between clamp body and cable end shall be obtained.

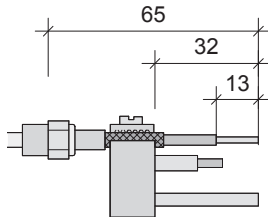

Picture 2 for Step 4 und 5: Strain relief

**Step 5:** Remove the interior insulation to a length of 13mm. Solve PE connection „A“ on the center pin of the strain relief. Shield under the basket (tighten the clamping strap using M5 nut (PE connection of the heating cable))

**Step 6:** Move sleeve with thread in direction of the connection cable over both ends of the heating coil. Connect the three pins as shown to the preassembled connection armature. Normal installation should be possible without force. If this is the case incorrect installation should be impossible.

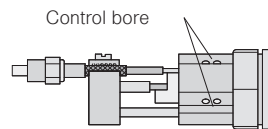

Picture 3 for Step 6 und 7: Clamp body

**Step 7:** Connect cable conductor and grounding to the clamp body. (The cable conductors should be visible through the control bore)

**Step 8:** See 6.1 Step 8

**Step 9:** See 6.1 Step 9

**Step 10:** See 6.1 Step 10

**Step 11:** See 6.1 Step 11

**6.3 ASSEMBLY INSTRUCTIONS FOR PARALLEL HEATING BANDS (GHP)**

**Step 1:** see 6.1 Step 1

**Step 2:** Move sleeve over the parallel heating band with thread in direction of the connection cable. Remove the corrosion protection, if existing, over a length of 65 mm. Dissolve the copper network (shielding) at a length of 55 mm and twist it afterwards. The given dimensions shall be maintained.

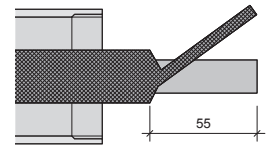

Picture 1 for Step 2

**Step 3:** Cut the isolation at the narrow side of the heating band for a length of 30 mm.

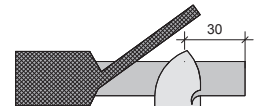

Picture 2 for Step 3

**Step 4:** Remove the outer isolation for 30 mm.

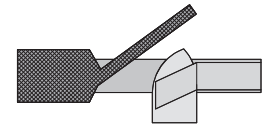

Picture 3 for Step 4

**Step 5:** Separate the both conductors by starting from the end.

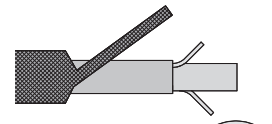

Picture 4 zu Step 5

**Step 6:** Remove the remaining heating element to 30 mm.

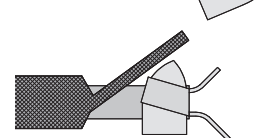

Picture 5 for Step 6

**Step 7:** Cut out the heating element with pliers.

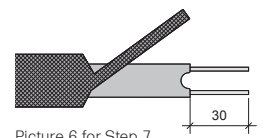

Picture 6 for Step 7

**Step 8:** Fit the heating band in the junction. Bolt with junction 2.

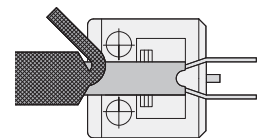

Picture 7 for Step 8

**Step 9:** Insert the copper network into the groove. Shorten all conductors to a length of 18 mm.

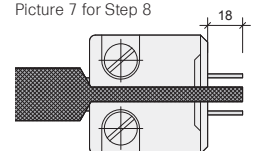

Picture 8 for Step 9

**Step 10:** Connect the conductors to the clamp of the lead through (Shielding on SL). The lacing should be visible through the control bore.

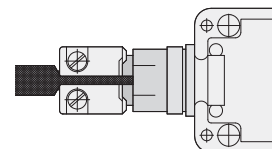

Picture 9 for Step 10

**Step 11:** Bolt the bushing with the prepotted part of the connection armature tight.

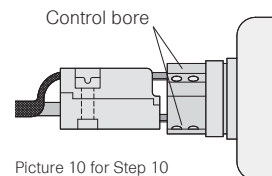

Picture 10 for Step 10

## 7.0 MOUNTING OPTIONS FOR GH AND GHT

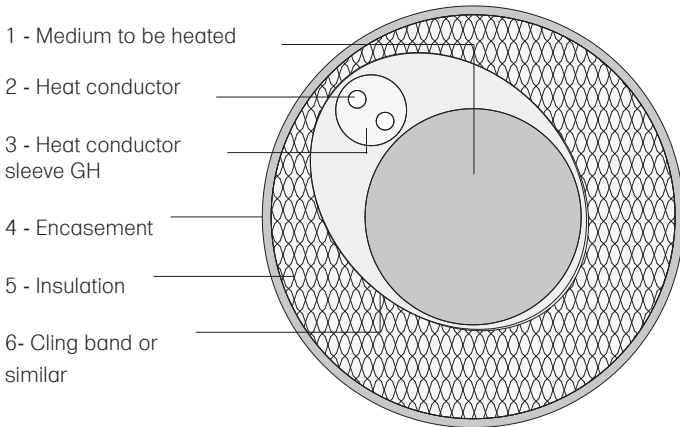

inside the encasement

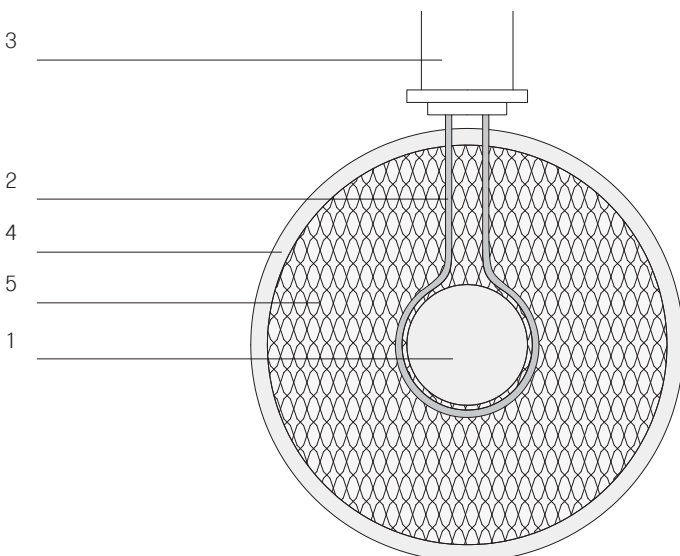
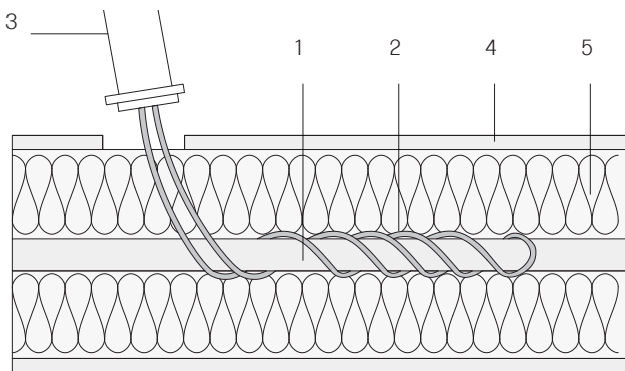

outside the encasement

Note: The heating cable must be connected flush with the medium to be heated.

## 8.0 CASTING RESIN

Casting resin set : 2855-T125

Not included! For further information please see the datasheet resin 2855-T125

1. Scope of delivery: 1 box component „A“, 1 box component „B“, 1 scraper made of wood
2. Storage: The date of expiry requires a vertical storage and storage temperature below 28°C. The integrity of the set can be checked by observing the information given in point 3. and 4..
3. Processing conditions The minimum handling and hardening temperature is +10°C. Both components have to be mixed without any rests. During handling no humidity shall enter the mixture (Limit: The total amount of water can untie the casting resin per set without blistering, equivalent to 2 drops of water with a hardness „KH“ of 20).
4. Use Open box „A“ with the scraper made of wood. If sediment is paste*, stir well until a homogeneous liquid is present. (It should not form any clumps). Open box „B“ and pour into box „A“, not the other way around. The residual volume must be less than 3%. Stir well with scraper (at least 1 ½ minutes). Please take care of not mixing any air. Mixing is finished when no cords are visible any more. Wait for another minute. The pottant may now be used to cast the connection armature for 4 minutes. The whole time from beginning until the end of the procedure may not last more than 12 minutes. The ambient temperature during operation shall not exceed 24°C. After 2 hours the pottant shall be that hard, that a deformation with a screw driver should not be possible and the surface may only be scratched with a sharp object (e.g. knife).**
* If the sediment can no longer be stirred, never lift off the precipitation but scratch it layer by layer and mix between each layer. Does it take longer than 15 minutes to get a homogenous fluid of substance „A“, the substance must be disposed. ** If the specifications can not be reached, the connection armature cannot be put into operation.

## 9.0 NAMEPLATE

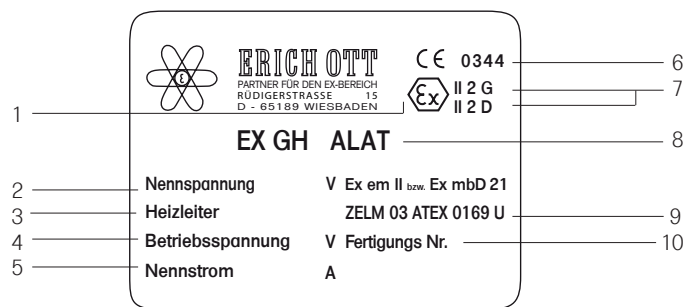

1-	Ex-labelling	6-	Supervising agency
2-	Nominal voltage	7-	Type of ignition protection
3-	Heat conductor	8-	Type designation
4-	Operating voltage	9-	Testing agency / EC - type examination certificate
5-	Rated current	10-	Serial number

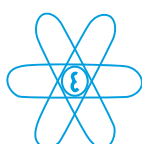



### 9.1 COMPLETION OF THE NAMEPLATE

The nameplate is a multi-layer design with extreme adhesiveness. For this reason a revision after gluing is impossible. Little bubbles or waves can not be removed after improper gluing. In the state of delivery the type plate has a laminate foil which cannot be removed after assembly. Flatten the foil from the connection to the open end and take care of bubbles and waves. Das After that preparation the type plate is resistant to most chemicals. Before flattening the laminate foil the type plate can be labelled with a lightfast pencil. Delivery condition is a labeling with production number. After the assembly of the cable connector the following values must be filled in by the engineer:

- Type of heating cable\*
- Nominal voltage
- Nominal current

After that the folding lamination must be closed.

\* The type coil must include information about length and specific resistance of the heating coil.

### 10.0 DIMENSIONS

The fittings have a diameter of 32 mm.  
The length of the valve depends on the type.

GH/ GHP	85 x 32 mm
GHL	100 x 32 mm
Polyester junction box	80x75x55mm
gland	M16 VA
Cage clamp on rail	2x PE
	1x L
	1x N

### 10.1 VARIATIONS

1	Polyester junction box including M16 VA Connection for mineral and Teflon insulated heating conductors	GH (T) PE + GH (T) M
2	Standard fittings for all heating cables	GH (T)
3	Polyester outlet for self-regulating heating cables	GHP PE + GHP M
4	Standard fittings for self-regulating heating cables	GHP + GHP M
5	Connecting sleeve as repair pieces at triac for all heating cables and tapes	GH (T/P) VM

