

SIPT AT

Power controller with temperature controller - limiter



Identification	 II2G EX e mb d IIC T4
EC-type examination certification	ISSeP 08 ATEX 023X
Ambient temperature range	-30°C - +40°C
Rated current	16 A
Control range	0 - 400 °C
Rated voltage	230 V
Monitoring	2 oder 3 Leiter
Protection degree	IP65

Power controller with temperature controller - limiter

The ideal solution for trace heating SIPT provides temperature control, limitation and power control in one device. The equipment includes temperature limiter and indicator lamp. All functional units are integrated in an anti-static standard housing.

SIPT is ATEX certified and approved for the use in hazardous areas in zone 1.

Cost-effective in maintenance and repair because of modular design. Designs with digital display and external actuation on possible on request.

Equipment and protective systems for the intended use in hazardous areas according to directive 94/9/EG (ATEX)

Power controller	SIPT AT
------------------	-----------------

TABLE OF CONTENT

1.0	General description	2
1.1	Fault signal relay	2
1.2	Overview of all available combinations	2
1.3	Special designs	2
2.0	General technical data	3
2.1	Technical data controller	3
2.2	Technical data limiter	3
2.3	Technical data semiconductor circuit	3
2.4	Technical data Min. monitoring	3
3.0	Serial number	4
3.1	Type code	4
4.0	Connection diagrams	4
5.0	Probe	4
5.1	Cables and lines	4
5.2	Setting of the target values	5
6.0	Switching and monitoring devices	5
7.0	Dimensions	6
7.1	Mounting holes	6
8.0	Nameplate	6



Warning

The installation, configuration and commissioning may only be carried out by accordingly trained persons. On-site installation and safety requirements must be met.



Proviso

Technical changes are reserved. Änderungen, Errors and printing errors do not justify any claim for compensation. For safety components and systems the relevant standards and regulations and the according operating and installation instructions must be observed.



Installation notes

The safety data of the circuits to be connected must be conform with the technical data or the provisions of the EC-type examination certificate.

For the establishment / operation the EN 60079-14, if applicable the standard series EN 60079-30, or EN 62086-1 and EN 62086-2 and the for in each case prevailing installation regulations as well as these operating instructions must be observed. The devices may mechanically not be strained more than it is provided by the norms and the included tests. If a deformation is seen on the device, it must be sent back for examination.

If during commissioning difficulties occur, we ask you not to carry out any unauthorized manipulations on the device. Otherwise the warranty and the validity of the EC-type examination certificate will void. Please contact us. In the case of service the device must be sent back to us.

Please note the additional assembly instructions on page 5 item 6.

Repair

The modular construction makes it possible to repair individual components. The unit must be returned to the manufacturer for examination and quotation. A repair is financially always preferable to a disposal and may only be carried out by the manufacturer.

Special conditions

1. The power controller SIPT must be fed by a fuse of 16 A, which has a switching capacity of 1500 A. 2. The terminal box can be equipped with an Ex e approved cable entry.

3. The accessories, such as temperature sensor and heating element, must be of an approved type. They are not included in the certification scope.



Notes on installation and operation

Before the device is taken into operation, the installation must be checked without device. An interchange of connections may lead to immediate destruction of the device.

The „technical data“ of these operating instructions for the power controller SIPT must be observed.

To operate the device with no lead in series and if this does not show the minimum resistance or more is prohibited.

The interconnection of individual approved components to one heating corresponds to a new unit with new, particularly thermal, flammable hazards.

Dismantling takes place in reverse order to mounting.

Maintenance

The applicable requirements of the EN 60079-14, if valid and applicable standard series EN 60079-30, or EN 62086-1 as well as EN 62086-2 for repair/ maintenance/ inspection must be observed. The equipment is maintenance free.

Read this operating instructions before you take the device into operation. Keep the operating instructions at a place accessible for all users at any time.

Please support us to improve these operating instructions. We are grateful for your suggestions.

Please contact us for technical checkback!
 TELEPHONE: +49 (0)611 761 393
 TELEFAX: +49 (0)611 711 462
 E-Mail: erichott@gmx.de

1.0 GENERAL DESCRIPTION

Characteristics

Field device for zone 1
Immediate overview of desired value and limiter
Signal lamp
2 sensor inputs
Parameterization easily understandable
Easy installation
Separate fault signal relay for both regulator and limiter
Sensor cable monitoring of all 3 conductors
Low temperature
Phase control

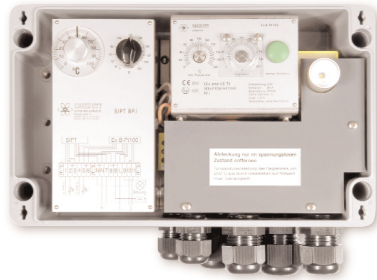

In its standard version the device has a voltage regulator with a control range of 20-230V~, a temperature regulator of 0-100°C, fault signal lamp and a limiter with a temperature range of 0-200°C. Device mit adjustable constant voltage output.

This is switched on and off by an integrated temperature controller. The connection cables up to 4 mm² are contacted with cage tension spring terminals. The test circuit is not intrinsically safe. It meets the relevant requirements for safety extra low voltage and ensures die EMV - compatibility. The high type of protection allows the operation under extreme conditions. There is no functional impairment due to condensation occurring in the terminal box.

Function

The controller is designed as a two-level controller and measures the temperature via PT 100. The limiter works as a standalone system and measures the temperature at the hot spot with its own PT 100. If the temperature exceeds the threshold value, the limiter stops the heating permanently and a signaling follows. Detailed information about the used limiter can be found in the operating manual of the temperature limiter Ex B Pt100.

With the min. monitoring a decrease of the temperature under a predetermined threshold value can be possibly recorded in time to resolve a disturbance before the occurrence of a damage. The temperature switch point is adjusted at the min. scale.

After a failure of the supply voltage all previous functions switch on again when the power returns, if the limiter circuit was not blocked by an excess temperature release. This saves the maintenance personnel from reconnecting (limiter resetting) each single controller by hand.

The setpoint adjuster of the limiter is sealable. The device is suited for small load resistances.

Sensors

Sensors, which are used in potentially explosive areas, must meet the requirements of the guideline 94/9/EG for the respective zone. In this context we can offer the temperature sensors from our product range. (See sensors). The load current is interrupted, no matter which of the 3 cables for the Pt 100 is disconnected. Furthermore an interruption occurs at conductor fault. The 3-wire circuit of the measuring input is as standard reduced to a 2-wire switch at the terminal strip by use of a bridge for short sensor lines and can be changed to a 3-wire switch..

1.1 FAULT SIGNAL RELAY

The fault signal relay responds to each of the following errors (Drop in rest position).

Limiter	Controller
Min.-temperature underflow	Min.-temperature underflow (only the model with digital display)
Triggered limiter	Sensor rash action
Sensor short circuit	Sensor break
Sensor break	Measuring cable interruption*
Measuring cable interruption*	Measuring line fault*
Measuring line fault*	
Power failure	

* no matter which of the 3 measuring lines is affected

Modular construction:

Because of the possibility to exchange single modules, this device can be repaired easily and is thus very easy to maintain, resulting in significant cost savings.

The modules are also available as single units as Ex ... R/ B.

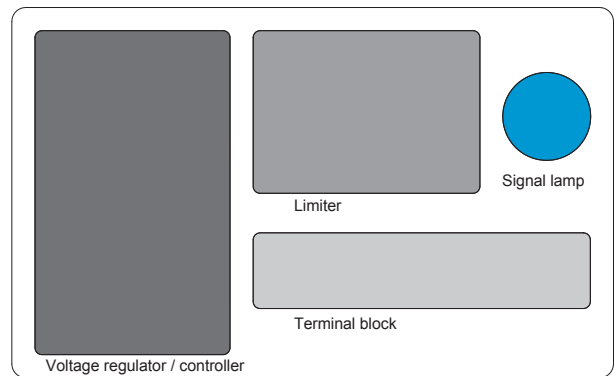

ISSeP 08 ATEX 023x

1.2 OVERVIEW OF ALL AVAILABLE COMBINATIONS

	Power selector	Controller	Limiter	External drive	Display	Failure lamp
SIPT AT	x	x	x	x	x	x
SIPT E	x	x		x	x	
SIPT A	x	x	x	x	x	x



1.3 SPECIAL DESIGNS

For special special applications we supply devices with additional functions (see type code):

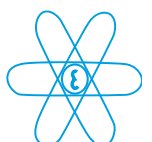
- Without limiter and pilot lights in a terminal box 160 mm x160 mm x 90mm.
- Min. monitoring at the limiter
- With and without external adjuster for the temperature
- Alternative control ranges up to +300°C.
- Alternative limiter ranges up to +400°C.
- Separate fault signal relay for controller
- With digital display



2.0 GENERAL TECHNICAL DATA

Nominal voltage	230V ±10% 50-60 Hz	
Protection degree	Min. IP65 / DIN 60529	
Admissible ambient temperature range	-30°C bis +40°C	
Dimensions	Width 260 mm Height 160 mm Depth 90 mm	
Electrical connection	clamps for 4 mm ²	
Mounting	Raster 240 mm x 110 mm for 4 x M4 screws	
EC - type examination certificate	ISSeP08ATEX023X	
Type of ignition protection (gas)	Ex e mbd II C T4	
IEC Standards	EN 60079-0, EN 60079-1, EN 60079-7, EN 60079-18	
Identification	 0344	 II 2G Ex e mb d IIC T4

The complete Atex approval documentation can also be found as PDF-document on www.erich-ott.de.

2.1 TECHNICAL DATA CONTROLLER

Rated current	60 mA (120 mA) Internal consumption
Insulation voltage*	2,5 kV~
Inputs-network	2,5 kV~
Network-cabinet	2,5 kV~ (* Inputs short-circuited)
Input-cabinet	2,5 kV~ (* Inputs short-circuited)
Sensor	Pt 100
Measuring current	6 mA, 3-conductor circuit
Measuring circuit monitoring	all 3 lines
Setting range temperature	0 ... 100/ 200/ 300/ 400°C
Setting range voltage	20 ... 230 V

2.2 TECHNICAL DATA LIMITER

Sensor input	Temperature sensor Pt100, Ni100
Measuring current	6 mA, 3-conductor switch
Measuring circuit monitoring	all 3 lines
Line break	≥ 200 Ω bei Pt100 (or 20 % above the indicated value range)
Short circuit	≥ 50 Ω (or 20 % above the measured value range)
Setting range/ Scale	0 ... 200/ 300/ 400°C
Limit adjuster	Precision potentiometer; rotation angle 300°
Switching point accuracy	≤ 1,5 %
Switching hysteresis	≤ 3 K (with 200°C scale)
Limiter relay	1 potential-free changeover contact 250/ 440 V ; 16 A (25 A)*; cos φ 0,7 ; 4000 VA (see load diagram)
Resetting	Key switch in front panel of the module
Upstreaming fuse	≤ 16 A
Requirement class	AK4

* max. inrush current impulse (4sec), no continuous operation

2.3 TECHNICAL DATA SEMICONDUCTOR CIRCUIT

Rated current	16 A (45 A)*
Power dissipation	~1 x Ib +5 (in Watt) (Ib = Operating current of the heating)
Resistance region of the heating cable	3 - 500 Ω without limiter **

* Rated current of the semiconductor

** see page.1 Notes on installation and operation

2.4 TECHNICAL DATA MIN. MONITORING

Setting range (scales)	0 ... 100/ 200/ 300/ 400°C
Set-point adjustment	Precision poti; angle of rotation 300°C
Switching point accuracy	≤ 1,5 %
Switching hysteresis	≤ 2 K (with 100°C scale)
Fault signal	by fault signal relay d2
1 potential-free make contact	250 V; 5 A cos φ 0,7; 1250 VA; 30 V=; 5 A; 150 W

3.0 SERIAL NUMBER

xxxx / 03.03

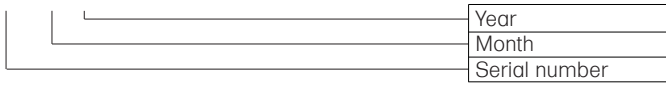

3.1 TYPE CODE



1	P	Primary element Pt100
	T	Thermal element
2	1	Measuring range for controller 100°C (standard)
	2	Measuring range for controller 200°C
	3	Measuring range for controller 300°C
	4	Measuring range for controller 400°C
3	2	Measuring range for limiter 200°C (Standard)
	3	Measuring range for limiter 300°C
	4	Measuring range for limiter 400°C
4	-	Standard
	A	With display
	E	Only voltage regulator + temperature controller*
5	-	Standard
	Ae	with external adjuster

*the fault signal lamp is not applicable for these designs

Example:
Device with measuring sensor Pt 100, measuring range for controller and limiter each 200 °C, with display and without external adjuster:

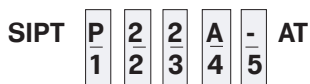

4.0 CONNECTION DIAGRAMS

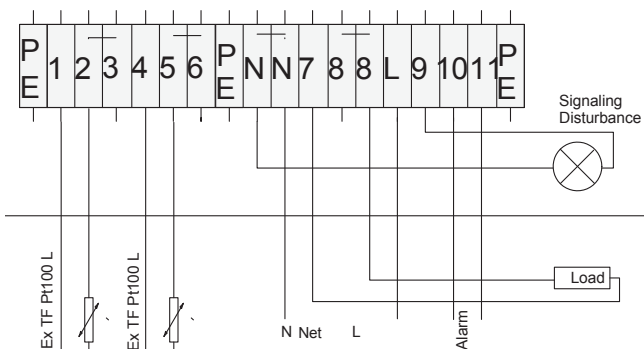

SIPT

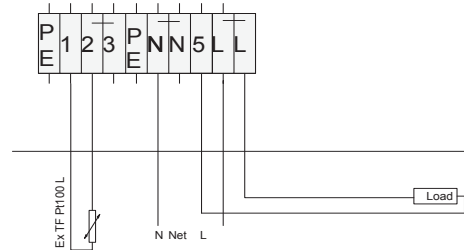

SIPT E

5.0 PROBE

The SIPT has two Pt100 inputs in 3-wire system at its disposal, at which appropriate temperature sensors can be operated in the hazardous area. The measuring sensor inputs are separately designed for controller and limiter and independent. Appropriate certified Pt100 measuring sensors are available in two basic designs:

Typ Ex TF Pt100L as sensor with minimum dimensions of 7,4 cm x 2,1 cm x 2,1 cm. Fully encapsulated in an aluminium cabinet with a measuring temperature of up to 200°C.

Typ Ex TF Pt100Ks with a measuring sensor tip of 5 mm and a length of 23 cm. Fully encapsulated in an aluminium cabinet, a stainless steel measuring sensor tip and a measuring temperature of up to 400°C.

Pt-100 measuring sensors are part of the EMV examination. Both measuring sensors are particularly safe of interfering voltage. For details see the product literature Pt-100Ks or Pt-100L.

Download at www.erich-ott.de

5.1 CABLES AND LINES

- Supply lines to the switch cabinet or rather distribution board must be desired in 3-wire or 5-wire technique.
- Only heating cables with external shielding are admissible. When used in hazardous areas of zone 1, suitable heating cables (eg according to EN 60079-7) must be used. These must be included in potential equalization. The screen may only be connected in the power regulator with protective conductor terminals (PE).
- Measuring and control line: There must always be two adjacent wires connected inside the cable for one signal. No control lines without pick-up or receiver may be connected. In pairtwisted lines, these lines must also be seized in pairs for a signal. The supply line for the heating element can, with suitable cable type, be carried in the same cable.

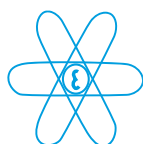

5.2 SETTING OF THE TARGET VALUES

Carry out basic settings in voltageless condition.

a) Limiter

Set the temperature set point of the limiter from the maximum value by turning to the left to the rated value. Seal the transparent cover. The set-point-adjusters have an adjustment protection, which is effective to slight vibrations. Proceed to the minimum setpoint as described. The minimum setpoint should be min. 5 K less than the limiter temperature .

b) Voltage regulator

Set the voltage setpoint at zero. Set the temperature setpoint above the current actual temperature. When all operating conditions are met and an effective value measuring ammeter is switched in row with the heating element, switch on supply voltage. Increase the output voltage by turning the voltage setpoint to the right until the calculated operating current is shown on the ammeter. Disconnect power, remove ammeter, control all connections, set temperature setpoint, switch on voltage.

6.0 SWITCHING AND MONITORING DEVICES

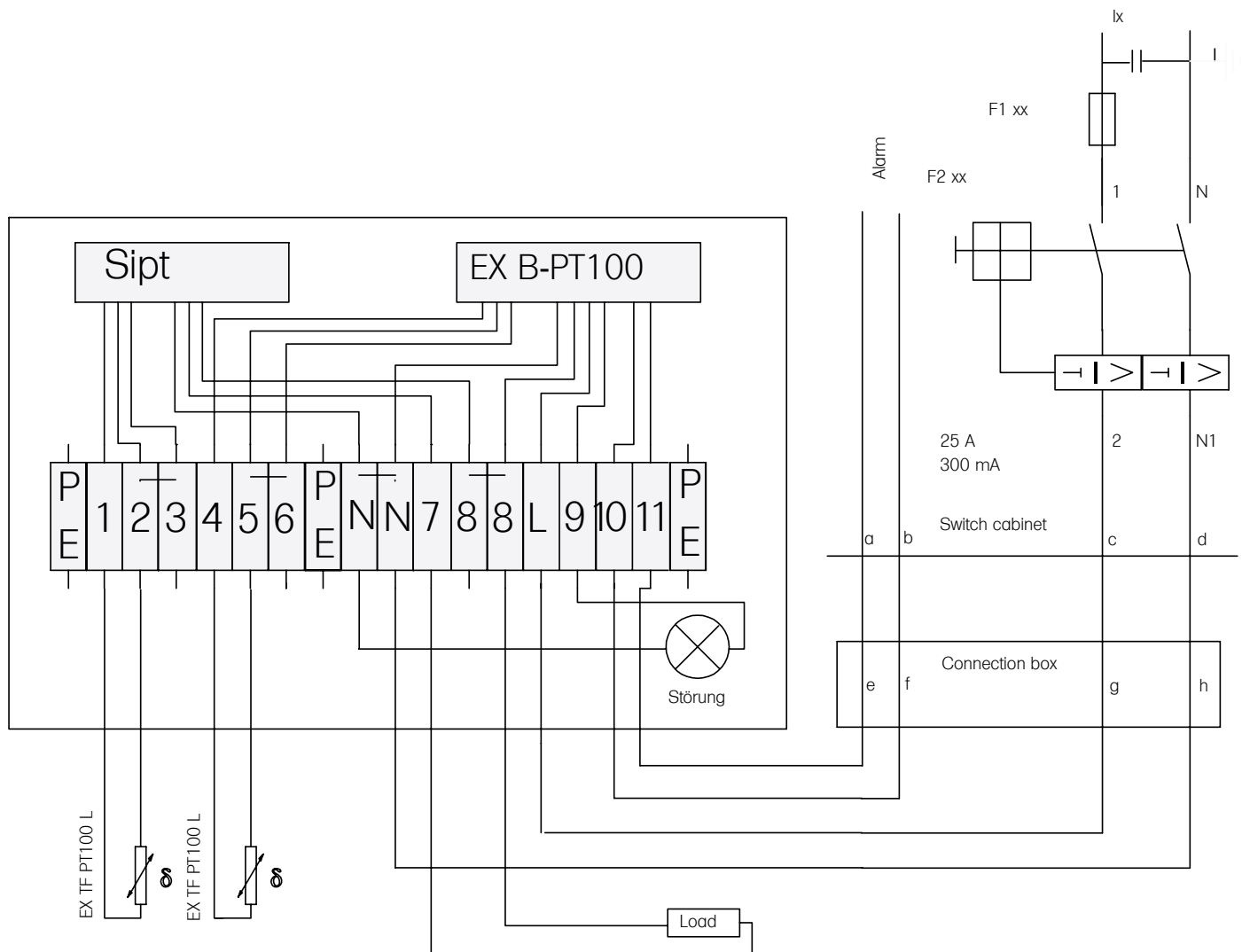

For the purpose of voltage supply a two pin disconnection element must be provided (Combination devices can include point a and b). See example drawing No.: 55 A 045:

a) FI: (fault current breaker) 300 mA. With phase angle control only one FI with symmetrical winding for upper waves is to be used (e.g. Siemens). Attention! Many FI's on the market are not suitable. FI's with a lower release

value than 300 mA must, depending on the type of feed line or the heating elements, be avoided (capacitive fault currents).

b) Fuses with 16 A and min. 4000 A switching capacity must be connected. The power selectors have no own protection devices for the power semiconductor. Fuses according to the rated current with switching characteristic F or automatic machines with characteristic H (or equivalent) must be used.

7.0 DIMENSIONS

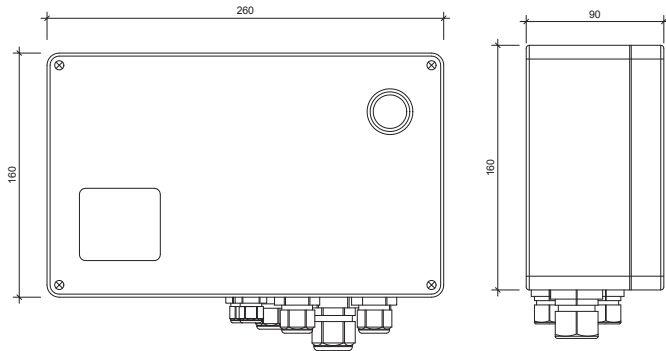

View

Section

8.0 NAMEPLATE

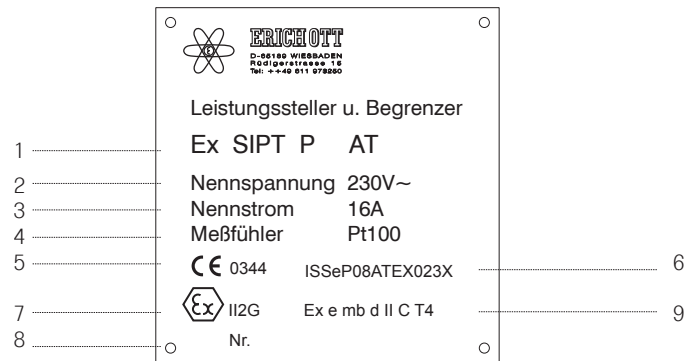

1-	Type designation	5-	Supervising agency
2-	Nominal voltage	6-	Inspecting authority/EC-type examination certificate
3-	Rated current	7-	Ex-identification
4-	Measuring sensor	8-	Production number
		9-	Ignition protection type

7.1 MOUNTING HOLES

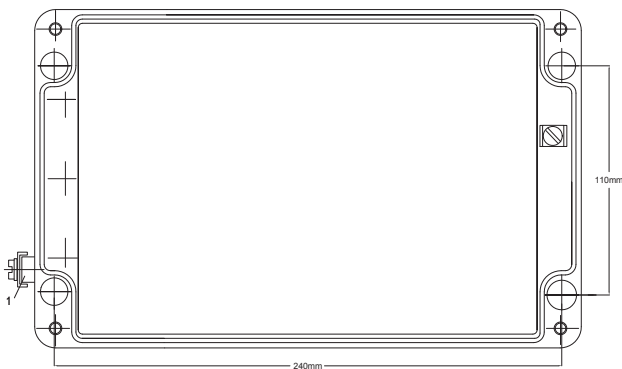

Reference hole when 110 x 240

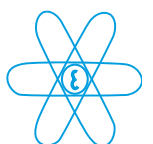
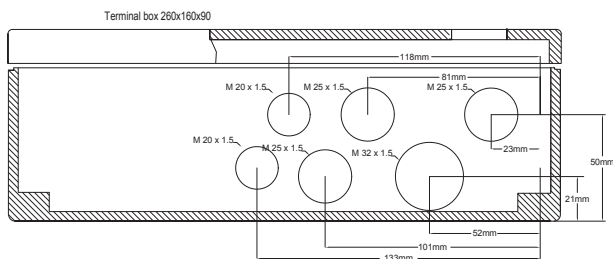

www.erich-ott.de



ERICH OTT 

Elektronische Geräte
Inh. Barica Ott

D- 65189 Wiesbaden
Rüdigerstrasse 15
Telephone +49 (0) 611 - 76 13 93
Telefax +49 (0) 611 - 71 14 62

mail erichott@gmx.de
web www.erich-ott.de