

Ex TBK/ TRK U

Capillary temperature controller and limiter

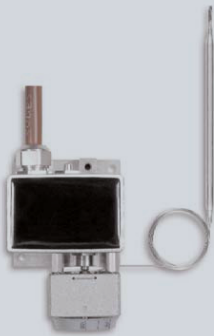

Features

Modules for Ex terminal box
Replaceable
Can be used as replacement
Available as regulator or limiter
Easy installation
Good readability of the temperatures
Versions for different temperature ranges

The basic units are designed for retrofitting and for mounting in a control system with separate EU-type examination certificate. The temperature controller and the temperature limiter is designed for the use in industrial plants and is used for temperature measurement of surfaces. In particular it is intended for heat tracing and heating within a protective cabinet Ex - area of zone 1 or higher.

The pressure-proof encapsulated switching element of the limiter has a manual reset mechanism.

Temperature changes are recorded by the sensor and directly transmitted through the capillaries and membranes to the precision snap-action switch. The switching temperature can be continuously adjusted by a hand wheel with temperature scale from 0°C. Temperature setting and limiter resetting can also be carried out under tension. The representation of the contact in the wiring diagram assumes that the sensor temperature is more than 5 % or rather 5°K lower than the temperature set on the setpoint turer.

ORDERING INFORMATION

For Limiter **Ex T**

1

K

2

 /

3

KAU

1	B	Limiter
	R	Controller
2	Temperature setting	
	5	0 to +50°C
	1	0 to +100°C
	3	0 to +300°C
3	Capillary length	
	1	1 m
	3	3 m
	5	5 m

Example:

Limiter with temperature setting of 0 - 50 °C and a capillary length of 1 m:

T

B

K

5

1

KAU

1

2

3

TECHNICAL DATA



Measuring ranges	0-50°C, 0-100°C and 0-300°C	
Capillary lengths	1m, 3 m, 5 m	
Switching voltage U_{Schalt}	$12 V \leq U_{Schalt} \leq 400 VA$	
Switching power I_{Schalt}	$0,01 A \leq I_{Schalt} \leq 16 A$	
Switching capacity P_{Schalt}	$0,12 W \leq P_{Schalt} \leq 4000 W$	
AC	$U_N \leq 400 V \sim \leq I_N \leq 16 A$	
DC	$U_N \leq 250 V, I_N \leq 0,25 A$	
Type of protection	IP65	
Dimensions cabinet (W x H x D): Mounting dimensions	91 x 60 x mm 50 x 50 mm	
Ambient temperature range exclusive capillaries	- 40°C - +60°C (Continuous service temperature cable $\leq 90^\circ C$)	
Cable gland	PG 9 Metal screw	
EU-type examination certificate	PTZ 16 ATEX 0020 X	
Type of ignition protection (gas)	II 2 G Ex db mb IIC T6 Gb or rather T5 or rather T4	
Identification	 0344	 II 2 G Ex db mb IIC T6 Gb

Table 1

Setting ranges	0..50°C	0..100°C	0..300°C
Cutoff accuracy*	± 1 K	± 1,5 K	± 4,5 K
Switching difference	± 1,5 K	± 3 K	± 9 K
max. sensor temperature	70°C	120°C	320°C
Sensor dimensions	6x250 mm	6x135 mm	4x175 mm
Capillaries (V4A)	1 / 3 / 5 m	1 / 3 / 5 m	1 / 3 / 5 m

* Factory settings. Depending on the ambient temperature this value can double.

LIMITER FUNCTION

After opening the case, the desired temperatures can be adjusted at the thermostates.

They operate on the principle of liquid expansion. If the temperature changes in the liquid-filled sensing systems (consisting of sensor, capillary and membranes) the volume changes. The thereby resulting movement of the membranes actuates the micro switch via lever.

When the set temperature is exceeded, the temperature controller switches from clamp 5 to clamp 6 and the temperature limiter switches from clamp 2 to clamp 3.

The safety thermostat can be turned on again by pressing the limiter release after the temperature drops. After setting the desired temperature the housing cover, gasket included (undamaged), must be mounted again, as this is the only way to guarantee protection IP 65 and the explosion protection.

LIMITER RESETTING

The safety temperature limiters are equipped with a lock-out. An automatic restart is not possible.

Each safety temperature limiter needs to be reset over manual reset button after correcting the failure.

The reset can only be done after reaching the normal operating conditions. At too high temperature the reset button is mechanically blocked. The release of the reset button is only possible after the fall below the nominal available.

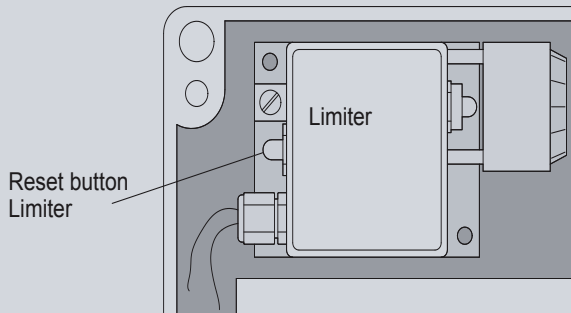

ASSEMBLY

There are two holes with a diameter of $\varnothing 4,3$ mm provided with which the device can be attached on the carrier plate of the Ex-housing by using two M4 (M5) screws DIN 84. Spacing for fixing see diagram wiring plan. The supply line can be safely transferred to the guidelines of the line installation.

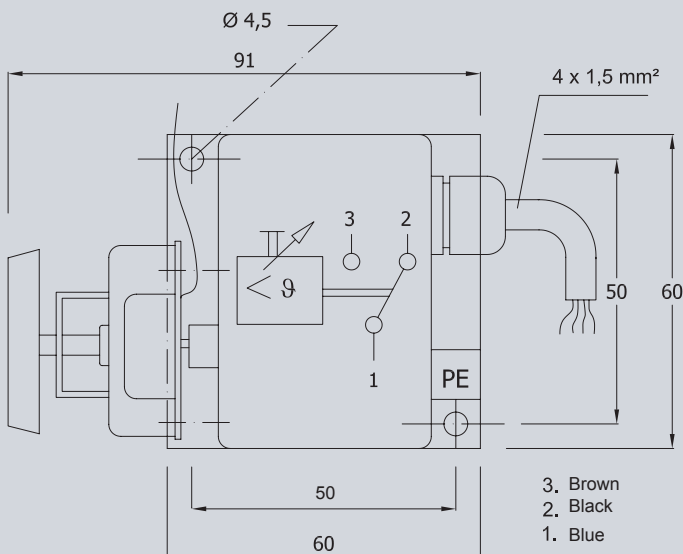

TYPE PLATE

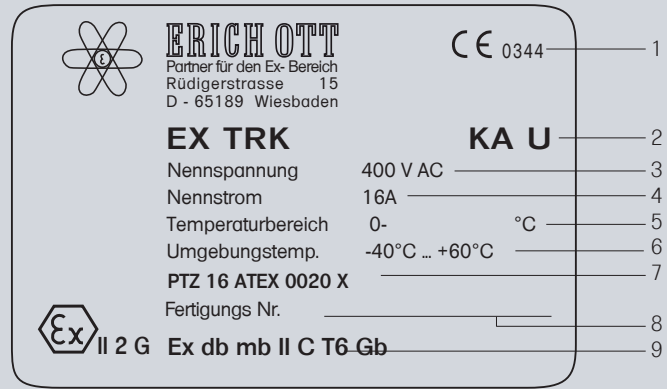

1-	Supervising agency	5-	Adjustable temperature range
2-	Type designation	6-	Admissible ambient temperature
3-	Nominal voltage	7-	Testing agency/ EU-type examination certificate
4-	Nominal current	8-	Serial number
		9-	Ex-Marking/ Ignition protection type

CIRCUIT DIAGRAM

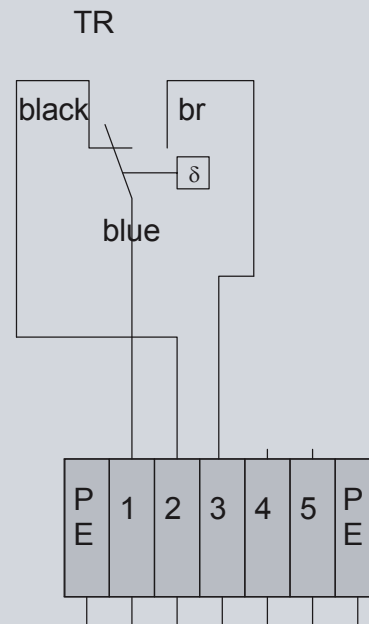

For more information please refer to the operating manual.
 Download at www.erich-ott.de